



**FD Trinitron**  
**WEGA**<sup>®</sup>

---

Operating Instructions

KD-27FS170  
KD-32FS170  
KD-36FS170



# WARNING

To reduce the risk of fire or electric shock, do not expose the TV to rain or moisture.

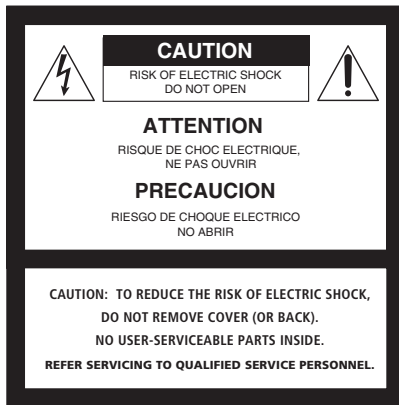

This symbol is intended to alert the user to the presence of uninsulated “dangerous voltage” within the product’s enclosure that may be of sufficient magnitude to constitute a risk of electric shock to persons.



This symbol is intended to alert the user to the presence of important operating and maintenance (servicing) instructions in the literature accompanying the appliance.

## Note to the CATV Installer

This reminder is provided to call the CATV system installer’s attention to Article 820-40 of the NEC that provides guidelines for proper grounding and, in particular, specifies that the cable ground shall be connected to the grounding system of the building as close to the point of cable entry as practical.

## SAFETY PRECAUTIONS

- Operate the TV only on 120 V AC.
- One blade of the power plug is wider than the other for safety purposes and will fit into the power outlet only one way. If you are unable to insert the plug fully into the outlet, contact your dealer.
- If any liquid or solid object falls into the TV, unplug it and have it checked by qualified personnel before operating it further.

## CAUTION

When using TV games, computers, and similar products with your TV, keep the brightness and contrast functions at low settings. If a fixed (non-moving) pattern is left on the screen for long periods of time at a high brightness or contrast setting, the image can be permanently imprinted onto the screen. Continuously watching the same channel can cause the imprint of station logos onto the TV screen. These types of imprints are not covered by your warranty because they are the results of misuse.



To reduce the risk of electric shock, do not use this polarized plug with an extension cord, receptacle, or other outlet unless the blades can be fully inserted to prevent blade exposure.



Pursuant to FCC regulations, you are cautioned that any changes or modifications not expressly approved in this manual could void your authority to operate this equipment.

## NOTIFICATION

This equipment has been tested and found to comply with the limits for a Class B digital device pursuant to Part 15 of the FCC Rules. These limits are designed to provide reasonable protection against harmful interference in a residential installation. This equipment generates, uses, and can radiate radio frequency energy and, if not installed and used in accordance with the instructions, may cause harmful interference with radio communications. However, there is no guarantee that interference will not occur in a particular installation. If this equipment does cause harmful interference to radio or television reception, which can be determined by turning the equipment off and on, the user is encouraged to try to correct the interference by one or more of the following measures:

- Reorient or relocate the receiving antennas.
- Increase the separation between the equipment and receiver.
- Connect the equipment into an outlet on a circuit different from that to which the receiver is connected.
- Consult the dealer or an experienced radio/TV technician for help.

## Protecting the TV

- To prevent internal heat build-up, do not block the ventilation openings.
- Do not install the TV in a hot or humid place, or in a place subject to excessive dust or mechanical vibration.

## Note on Caption Vision

This television receiver provides display of television closed captioning in accordance with § 15.119 of the FCC rules. Use of this television for other than private viewing of programs broadcast on UHF or VHF or transmitted by cable companies for the use of the general public may require authorization from the broadcaster-cable company and/or program owner.

## Owner’s Record

The model and serial numbers are located on the front cover of this manual and at the rear of your TV.

## Trademarks and Copyrights



As an ENERGY STAR® Partner, Sony Corporation has determined that this product meets the ENERGY STAR® guidelines for energy efficiency. ENERGY STAR® is a U.S. registered mark.



Manufactured under license from Dolby Laboratories Licensing Corporation. Dolby and the double-D symbol are trademarks of Dolby Laboratories.

# IMPORTANT SAFEGUARDS

For your protection, please read these instructions completely, and keep this manual for future reference. Carefully observe and comply with all warnings, cautions and instructions placed on the set, or described in the operating instructions or service manual.

## WARNING

To guard against injury, the following basic safety precautions should be observed in the installation, use, and servicing of the set.

## Use

### Power Sources

This set should be operated only from the type of power source indicated on the serial/model plate. If you are not sure of the type of electrical power supplied to your home, consult your dealer or local power company. For those sets designed to operate from battery power, refer to the operating instructions.



### Grounding or Polarization

This set may be equipped with a polarized alternating current line plug (a plug having one blade wider than the other). This plug will fit into the power outlet only one way. This is a safety feature. If you are unable to insert the plug fully into the outlet, try reversing the plug. If the plug still fails to fit, contact your electrician to replace your obsolete outlet. Do not defeat the safety purpose of the polarized plug.



### For the set with a three-wire grounding type AC plug

This plug will only fit into a grounding-type power outlet. This is a safety feature. If you are unable to insert the plug into the outlet, contact your electrician to have a suitable outlet installed. Do not defeat the safety purpose of the grounding plug.

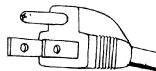

### Overloading

Do not overload wall outlets, extension cords or convenience receptacles beyond their capacity, since this can result in fire or electric shock.

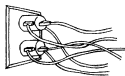

Always turn the set off when it is not to be used. When the set is left unattended and unused for long periods of time, unplug it from the wall outlet as a precaution against the possibility of an internal malfunction that could create a fire hazard.

Do not disconnect the antenna or the power cord during a heavy storm. Lightning may strike while you are holding the cable or cord, causing serious injury. Turn off your TV and wait for the weather to improve.

### Object and Liquid Entry

Never push objects of any kind into the set through the cabinet slots as they may touch dangerous voltage points or short out parts that could result in a fire or electric shock. Never spill liquid of any kind on the set.



## Corrosion

Do not use the set close to the ocean since it may cause the set to be exposed to excess salt, corrosion, and internal damage and will deteriorate its performance. If you expose the TV to these conditions, you should take the necessary precautions to reduce the humidity and temperature of the area in which the set is located.

## Attachments

Do not use attachments not recommended by the manufacturer, as they may cause hazards.

Do not place any objects, especially heavy objects, on top of the set. The object may fall from the set, causing injury.



## Cleaning

Unplug the set from the wall outlet before cleaning or polishing it. Do not use liquid cleaners or aerosol cleaners. Use a cloth lightly dampened with water for cleaning the exterior of the set.



If a snapping or popping sound from a TV set is continuous or frequent while the TV is operating, unplug the TV and consult your dealer or service technician. It is normal for some TV sets to make occasional snapping or popping sounds, particularly when being turned on or off.



## Installation

Always use two or more people to lift or move the set. The set is heavy and the bottom surface is flat. Serious injury can result from trying to move the set by yourself alone, or from unsteady handling.

Install the set on a stable, level surface.

## Water and Moisture

Do not use power-line operated sets near water — for example, near a bathtub, washbowl, kitchen sink, or laundry tub, in a wet basement, or near a swimming pool, etc.

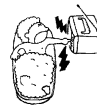

## Accessories

Do not place the set on an unstable cart, stand, tripod, bracket, table, or shelf. The set may fall, causing serious injury to a child or an adult, and serious damage to the set. Use



only a cart or stand recommended by the manufacturer for the specific model of TV. Any mounting of the product should follow the manufacturer's instructions, and should use a mounting accessory recommended by the manufacturer. An appliance and cart combination should be moved with care. Quick stops, excessive force, and uneven surfaces may cause the appliance and cart combination to overturn.

## Ventilation

The slots and openings in the cabinet and in the back or bottom are provided for necessary ventilation. To ensure reliable operation of the set, and to protect it from overheating, these slots and openings must never be blocked or covered.

- Never cover the slots and openings with a cloth or other materials.



- Never block the slots and openings by placing the set on a bed, sofa, rug or other similar surface.

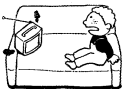

- Never place the set in a confined space, such as a bookcase or built-in cabinet, unless proper ventilation is provided.



- Do not place the set near or over a radiator or heat register, or where it is exposed to direct sunlight.



## Power-Cord Protection

Do not allow anything to rest on or roll over the power cord, and do not place the set where the power cord is subject to wear or abuse.



## Antennas

### Outdoor Antenna Grounding

If an outdoor antenna is installed, follow the precautions below. An outdoor antenna system should not be located in the vicinity of overhead power lines or other electric light or power circuits, or where it can come in contact with such power lines or circuits.

WHEN INSTALLING AN OUTDOOR ANTENNA SYSTEM, EXTREME CARE SHOULD BE TAKEN TO KEEP FROM CONTACTING SUCH POWER LINES OR CIRCUITS AS CONTACT WITH THEM IS ALMOST INVARIABLY FATAL.

Be sure the antenna system is grounded so as to provide some protection against voltage surges and built-up static charges. Section 810 of the National Electrical Code (NEC) in USA and Section 54 of the Canadian Electrical Code in Canada provides information with respect to proper grounding of the mast and supporting structure, grounding of the lead-in wire to an antenna discharge unit, size of grounding conductors, location of antenna discharge unit, connection to grounding electrodes, and requirements for the grounding electrode.

### Antenna Grounding According to the NEC

Antenna Grounding According to the National Electrical Code, ANSI/NFPA 70.

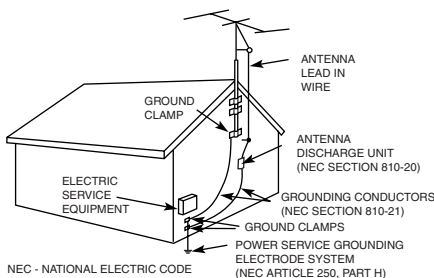

NEC - NATIONAL ELECTRICAL CODE

## Lightning

For added protection for this television receiver during a lightning storm, or when it is left unattended and unused for long periods of time, unplug it from the wall outlet and disconnect the antenna. This will prevent damage to the receiver due to lightning and power-line surges.

## Service

### Damage Requiring Service

Unplug the set from the wall outlet and refer servicing to qualified service personnel under the following conditions:

- When the power cord or plug is damaged or frayed.



- If liquid has been spilled into the set or objects have fallen into the product.



- If the set has been exposed to rain or water.



- If the set has been subject to excessive shock by being dropped, or the cabinet has been damaged.

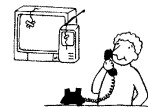

- If the set does not operate normally when following the operating instructions. Adjust only those controls that are specified in the operating instructions. Improper adjustment of other controls may result in damage and will often require extensive work by a qualified technician to restore the set to normal operation.



- When the set exhibits a distinct change in performance — this indicates a need for service.

## Servicing

Do not attempt to service the set yourself since opening the cabinet may expose you to dangerous voltage or other hazards. Refer all servicing to qualified service personnel.



## Replacement Parts

When replacement parts are required, be sure the service technician certifies in writing that he has used replacement parts specified by the manufacturer that have the same characteristics as the original parts. Unauthorized substitutions may result in fire, electric shock, or other hazards.



## Safety Check

Upon completion of any service or repairs to the set, ask the service technician to perform routine safety checks (as specified by the manufacturer) to determine that the set is in safe operating condition, and to so certify. When the set reaches the end of its useful life, improper disposal could result in a picture tube implosion. Ask a qualified service technician to dispose of the set.



# Contents

## Introduction

Introducing the FD Trinitron WEGA Features .....	1
About this Manual .....	2
Batteries for the Remote Control .....	2
Front Panel Menu Controls .....	2

## Using the Remote Control

Remote Control Description .....	3
----------------------------------	---

## Connecting Your TV

TV Rear Panel .....	5
Basic Connections .....	6
Connecting Additional Equipment .....	7

## Setting Up the TV .....

## Using the Digital Features

Overview .....	14
Tuning to a Digital Channel .....	14
Using the Digital Program Guide .....	15
Using Digital Favorite Channels .....	16
Using the Screen Mode Feature .....	17

## Using the Analog Menus

Overview .....	18
Menu Descriptions .....	18
Using the Remote Control to Display and Navigate the On-Screen Analog Menus .....	20
Using the Video Menu .....	21
Using the Channel Setup Menu .....	22
Using the Parental Control Menu .....	23
Parental Control .....	24
United States: Selecting Custom Rating Options .....	25
Canada: Selecting Custom Rating Options .....	26
Using the Clock/Timers Menu .....	27
Using the Setup Menu .....	28
Using the Digital Features Menu .....	29

## Using the Digital Menus

Menu Descriptions .....	30
Using the Remote Control to Display and Navigate the On-Screen Digital Menus .....	30
Using the Digital Channels Menu .....	31
Using the Digital Setup Menu .....	32
Using the Parental Lock Menu .....	34

## Other Information

Troubleshooting .....	35
Specifications .....	38

<b>Index</b> .....	39
--------------------	----

# Introduction

Congratulations on your purchase of the Sony FD Trinitron WEGA®.

## Introducing the FD Trinitron WEGA Features

Some of the features you will enjoy include:

- ❑ **FD Trinitron Flat CRT** — Delivers a picture with uncompromising accuracy and outstanding image detail via a technologically advanced tube.
- ❑ **Analog and Digital Receivers** — Built-in tuners allow you to receive both analog (NTSC) and digital (ATSC) programming. Digital programming is available only via terrestrial signals over-the-air.
- ❑ **Wide Screen Mode** — Watch digital 16:9 (widescreen) broadcasts in their original widescreen format, or zoom to fill the 4:3 aspect ratio screen.
- ❑ **YPbPr Inputs** — Provides component video inputs for superior picture quality (480i only).
- ❑ **Parental Control (V-Chip)** — Helps parents monitor what their children watch on TV by establishing rating limits.
- ❑ **ClearEdge VM** — Sharpen picture definition to give objects a crisp, clear edge (only for KD-32FS170 and KD-36FS170 models).
- ❑ **Favorite Channels** — Enables you to set up separate Favorite Channel lists for analog and digital channels.
- ❑ **Digital Program Guide** — Select digital channels from an on-screen program guide.
- ❑ **ENERGY STAR®** — Meets the ENERGY STAR® guidelines for energy efficiency.
- ❑ **Front Panel Controls** — Allows access to the on-screen menus without the use of a remote control.
- ❑ **Front A/V Inputs** — Lets you quickly connect video games, camcorders, or stereo/mono equipment.



## About this Manual

This manual provides instructions to help you enjoy your new TV. It shows you how to connect to an antenna or cable, cable box, VCR, DVD, satellite receiver or camcorder. Once your TV is connected, follow the instructions and use the remote control to access the on-screen menus.

## Batteries for the Remote Control

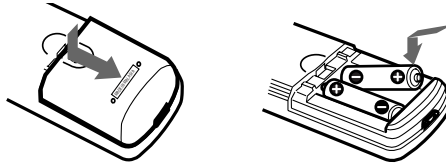
Insert two AA batteries (supplied) into the remote control using the following illustration as a guide.



-  Under normal conditions, batteries will last up to six months. If the remote control does not operate properly, the batteries might be worn out.
-  If you will not be using the remote control for an extended period of time, remove the batteries to avoid possible damage from battery leakage.

## Front Panel Menu Controls

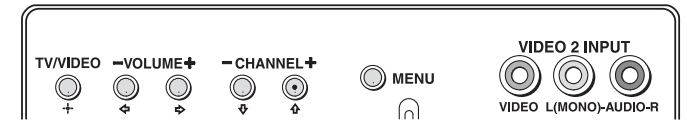

The front panel controls allow you to access the menu without the remote control.

- Press the **MENU** button to display the on-screen menu.
- Use the  $\leftarrow \rightarrow$  (**- VOLUME +**),  $\updownarrow$  (**- CHANNEL +**) buttons on the front panel to navigate through the menus, then press  $\leftarrow$  (**TV/VIDEO**) to select an item. The front panel controls also allows you to change your channels, adjust the volume and change video inputs.

-  To navigate the menus with your remote control, see pages 20 and 30.



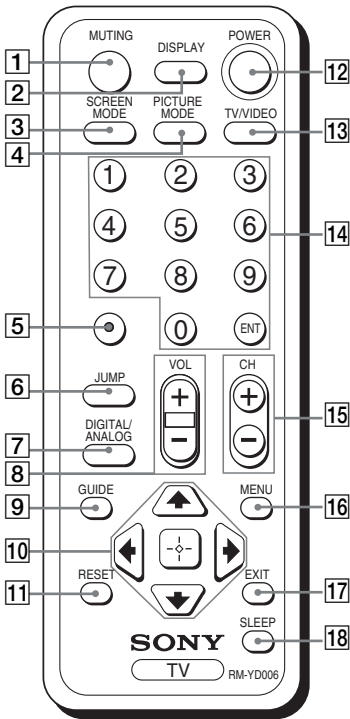

# Using the Remote Control

## Remote Control Description



**D** Indicates feature available only in digital tuning mode.

Button	Description
<b>1</b> <b>MUTING</b>	Press to turn off the sound. Press again or press VOL+ to restore sound.
<b>2</b> <b>DISPLAY</b>	Press once to display the current time (if set) and the program status such as channel number, Channel Label (if set), video input, Video Label (if set), and Info Banner (if set). Press again to turn off the display.
<b>3</b> <b>SCREEN MODE</b>	<b>D</b> Press repeatedly the Screen Mode options. For details on using Screen Mode, see page 17. Also available in the Digital Setup menu (see page 32).
<b>4</b> <b>PICTURE MODE</b>	Press repeatedly to step through the available video picture modes: Vivid, Standard, Movie, and Pro. Also available in the Video menu. See "Using the Video Menu" on page 21 for details.
<b>5</b> 	<b>D</b> Use with 0-9 and ENT buttons to select digital channels (for example, 2.1). For details on selecting digital channels, see page 14.
<b>6</b> <b>JUMP</b>	Press to jump back and forth between the current channel and the last channel that you selected. (JUMP does not switch between analog and digital channels.)
<b>7</b> <b>DIGITAL/ANALOG</b>	Press to switch between digital and analog tuning modes.
<b>8</b> <b>VOL (volume)</b>	Press (+) or (-) to adjust the volume.
<b>9</b> <b>GUIDE</b>	<b>D</b> Press to display the digital program guide. For details, see page 15.
<b>10</b> 	Press the arrow buttons to move the cursor in the on-screen menus. Press the center button to select an option. (If no menu or display is shown, pressing the center button displays the Favorite Channels list.)
<b>11</b> <b>RESET</b>	Press to return to factory settings while in an on-screen menu.
<b>12</b> <b>POWER</b>	Press to turn on/off the TV.
<b>13</b> <b>TV/VIDEO</b>	Press to cycle through available video inputs.
<b>14</b> <b>0-9 and ENT</b>	Press 0-9 to select a channel; the channel changes after 2 seconds. Press ENT to change channels immediately.
<b>15</b> <b>CH (channel)</b>	Press to change channels. The channel will change according to the current tuning mode (analog or digital). To scan rapidly through the channels, press and hold down the CH+ or CH- button.
<b>16</b> <b>MENU</b>	Press to display and exit the analog menu. To display the digital menu, see page 30. (For details, see page 18)

Button	Description
<b>17</b> EXIT	Press to exit menus and other on-screen displays.
<b>18</b> SLEEP	Press repeatedly until the TV displays the time in minutes (15, 30, 45, 60, or 90) that you want the TV to remain on before shutting off automatically. Cancel by pressing until Sleep Off appears.

 If you lose your remote control, see page 36.

# Connecting Your TV

Read this section before setting up your TV for the first time. This section explains how to make the basic connections and how to connect optional equipment.

## TV Rear Panel

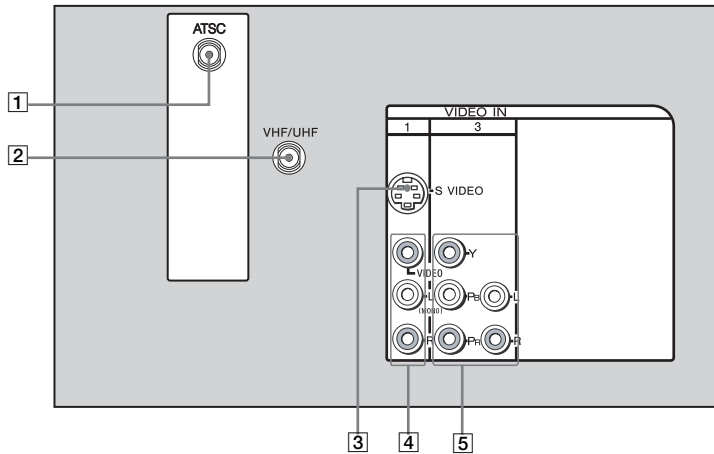

Jack	Description
<b>1 ATSC</b>	This input connects to your VHF/UHF antenna or digital cable box for digital signal (ATSC).
<b>2 VHF/UHF</b>	This input connects to your VHF/UHF antenna or cable for analog signal (NTSC).
<b>3 S VIDEO</b>	This input connects to the S VIDEO OUT jack on your VCR or other video equipment that has S VIDEO. S VIDEO provides better picture quality than the VHF/UHF jacks or the video input jack. S VIDEO does not provide sound; connect the audio cable.
<b>4 VIDEO/AUDIO L(MONO), R</b>	This input connects to the AUDIO/VIDEO output jacks on your VCR or other video equipment. A third video input jack (VIDEO 2) is located on the front panel of the TV. These AUDIO/VIDEO input jacks provide better picture quality than the VHF/UHF jack.
<b>5 YP<sub>B</sub>P<sub>R</sub>/ L, R</b>	This input connects to the component video YP <sub>B</sub> P <sub>R</sub> and AUDIO L, R jacks on your DVD player or digital set-top box (480i only).

## Basic Connections

### TV with Cable, Indoor, or Outdoor Antenna

Depending on the cable system available in your home, choose one of the connections below:

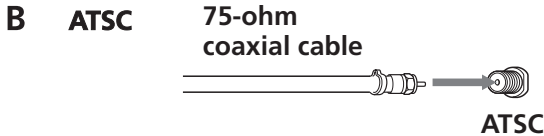
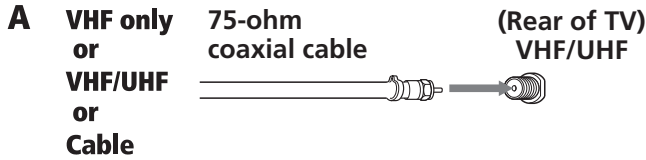

Use option A to connect the TV to a cable system or an antenna with a 75-ohm cable.

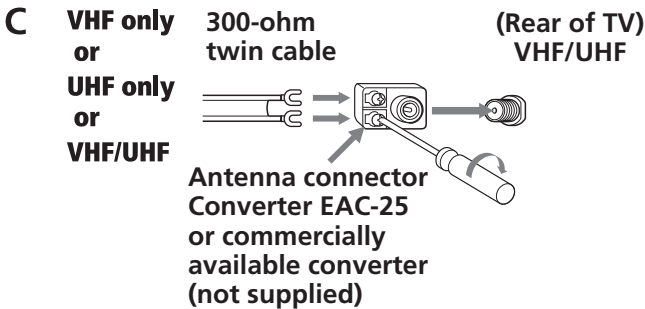

Converter EAC-25 is commercially known as a 300-to-75 ohm antenna adapter.

Use option B to connect the TV to a dipole antenna, also known as a “rabbit ears antenna”.

If you are connecting to an indoor or outdoor antenna, you may need to adjust the orientation of the antenna for the best reception.

### Connecting Two RF Inputs

If you want to watch RF signals for both antenna (over-the-air) and cable broadcast signals, you’ll need to use an optional A-B switch for RF inputs (not supplied), as shown below.

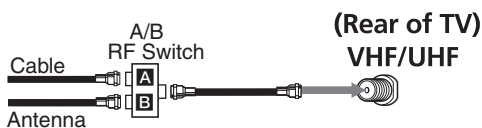

Use the A-B selector to switch between the over-the-air signals and the cable signals. Then set the **Cable** setting in the Channel Setup menu to **On** or **Off**, as described on page 22.

For best results, be sure to use an RF switch, as shown above, instead of a simple splitter.

# Connecting Additional Equipment

## Connecting a DVD Player using Composite Video (VIDEO/AUDIO L(MONO),R)

Using audio/video cables (not supplied), connect AUDIO/VIDEO OUT on your DVD player to AUDIO/VIDEO IN on your TV.

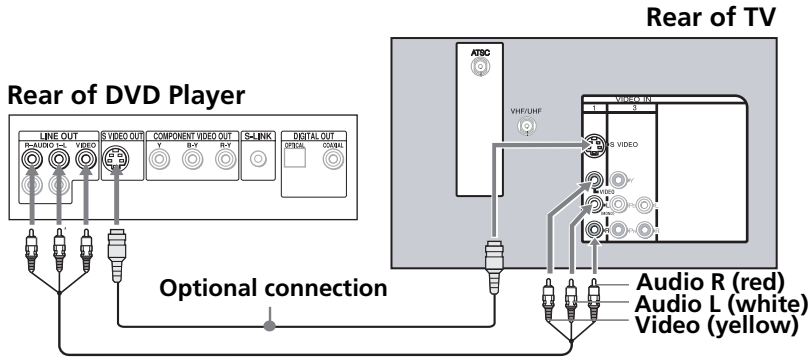

### Optional connection

- ❑ For better picture quality, use S VIDEO (located on the rear panel) instead of the yellow video cable. S VIDEO does not provide sound, so you still must connect the audio cables.

## Connecting a DVD Player using Component Video (YP<sub>B</sub>P<sub>R</sub> R L)

If your DVD player is equipped with component video outputs (YP<sub>B</sub>P<sub>R</sub>), you can improve the picture quality by using component video cables (480i only).

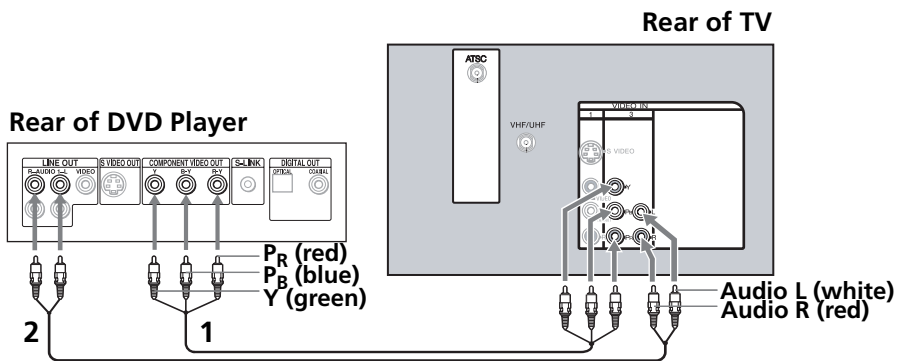

- 1** Make sure your DVD player is set up (see page 35). Using component video cables (not supplied), connect YP<sub>B</sub>P<sub>R</sub> OUT on your DVD player to YP<sub>B</sub>P<sub>R</sub> IN on your TV.
- 2** Connect AUDIO OUT on your DVD player to AUDIO IN on your TV.

 The YP<sub>B</sub>P<sub>R</sub> outputs on your DVD player are sometimes labeled Y, C<sub>B</sub>, and C<sub>R</sub> or Y, B-Y, and R-Y. If so, connect the cables to like colors.

# Connecting a TV and VCR

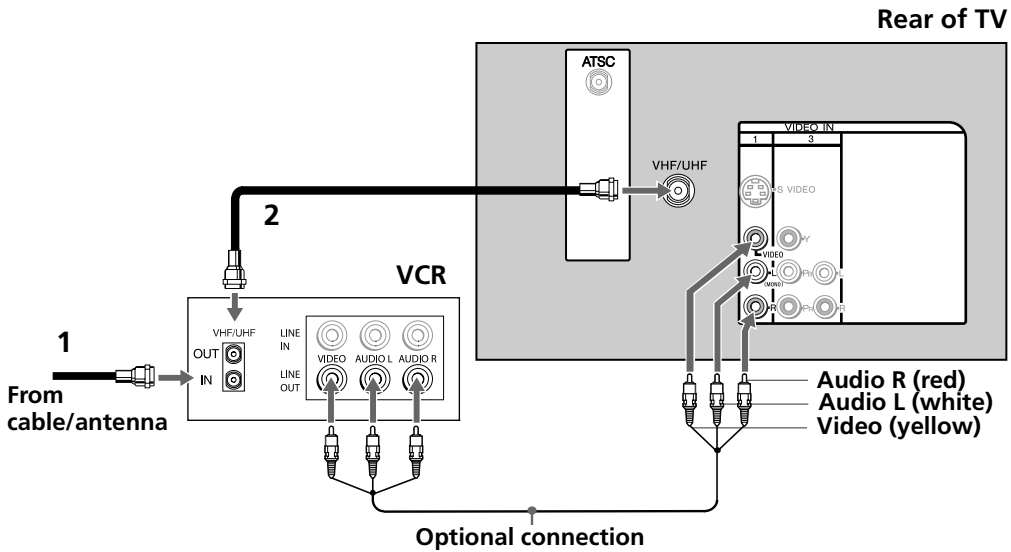

- 1 Connect the coaxial cable from your TV antenna or cable service to the IN jack on your VCR.
- 2 Connect a coaxial cable (not supplied) from the OUT jack on your VCR to the VHF/UHF jack on the TV.

### Optional connection

- ❑ If your VCR is equipped with video outputs, you can get better picture quality by connecting audio/video cables (not supplied) from AUDIO/VIDEO OUT on your VCR to AUDIO/VIDEO IN on your TV.
- ❑ For better picture quality, use S VIDEO (located on the rear panel) instead of the yellow video cable. S VIDEO does not provide sound, so you still must connect the audio cables.

To watch video programs from your VCR, tune your TV to Channel 3 or 4 (as set on the rear of your VCR).

You can use the button to switch between the VHF/UHF and VIDEO inputs.

## Connecting a TV and Cable Box

Some cable TV systems use scrambled or encoded signals that require a cable box to view all channels. If you subscribe to such type of service, use this connection.

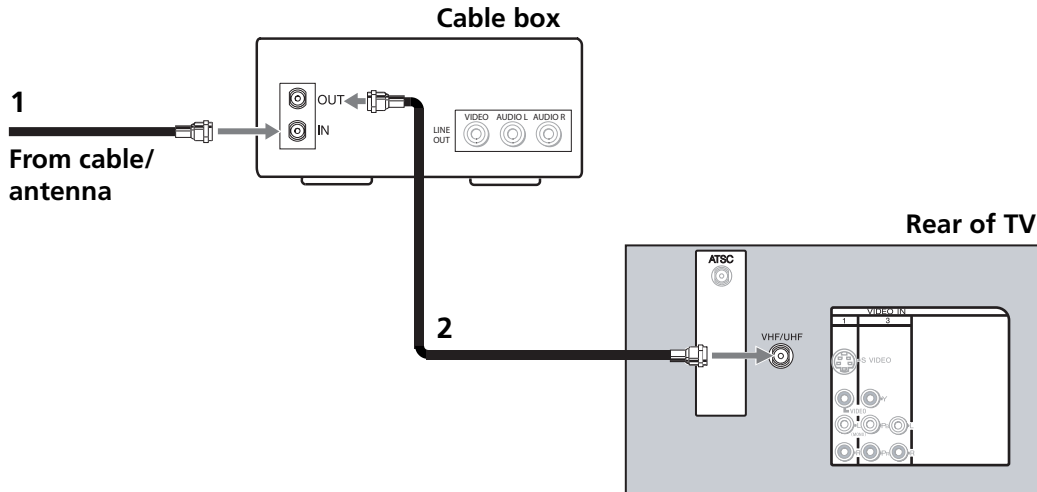

- 1** Connect the coaxial cable from your cable service to the IN jack on your cable box.
- 2** Connect a coaxial cable (not supplied) from the OUT jack on your cable box to the VHF/UHF jack on your TV.

### Optional connection

- ❑ To view channels from your cable box, tune your TV to channel 3 or 4 (as set on the rear panel of your cable box) and use the cable box's remote control to change channels.
- ❑ If you will be controlling all channel selection through your cable box, you should consider using the Channel Fix feature by setting your TV to channel 3 or 4 (see page 22).

## Connecting a TV and Satellite Receiver

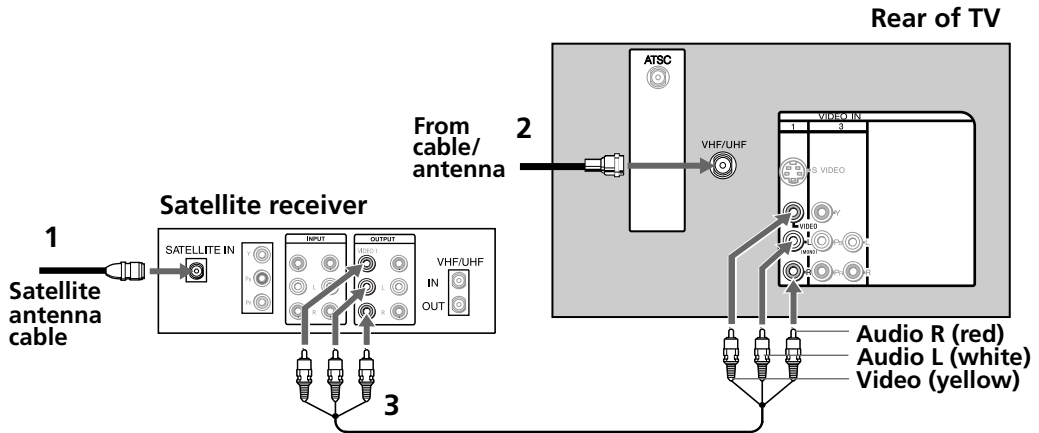

### Connections

- 1 Connect the cable from your satellite antenna to SATELLITE IN on your satellite receiver.
- 2 Connect the coaxial cable from your cable service or antenna to the VHF/UHF jack on your TV.
- 3 Using audio/video cables (not supplied), connect AUDIO/VIDEO OUT on your satellite receiver to AUDIO/VIDEO IN on your TV.

To watch video programs from your Satellite receiver, tune your TV to channel 3 or 4.

You can use the button to switch between the VHF/UHF and VIDEO inputs.



## Connecting a TV, VCR, and Satellite Receiver using Component Video (YP<sub>B</sub>P<sub>R</sub>)

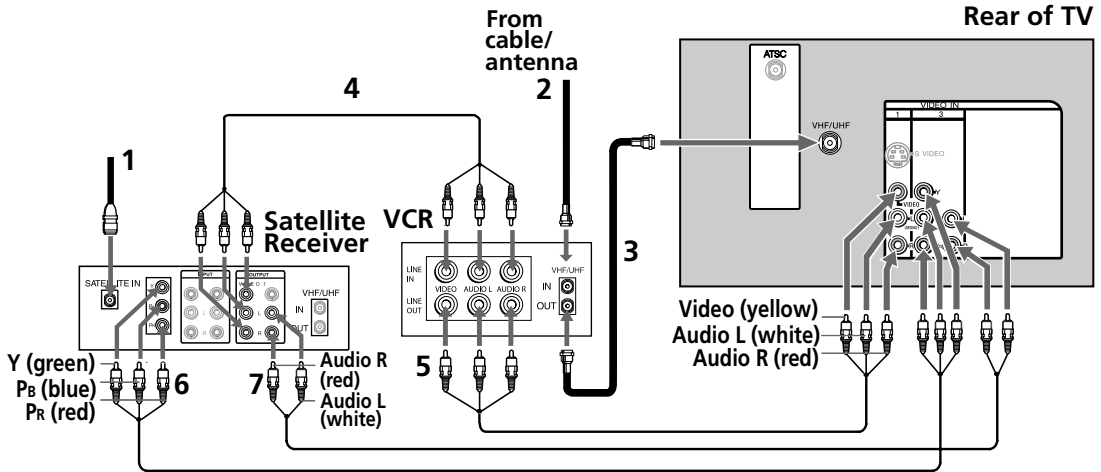

- 1** Connect the coaxial cable from your satellite antenna to SATELLITE IN on the satellite receiver.
- 2** Connect the coaxial cable from your cable service or antenna to the IN jack on your VCR.
- 3** Using a coaxial cables (not supplied), connect the OUT jack on your VCR to the VHF/UHF jack on your TV.
- 4** Using audio/video cables (not supplied), connect AUDIO/VIDEO OUT on your satellite receiver to AUDIO/VIDEO IN on your VCR.
- 5** Using audio/video cables (not supplied), connect AUDIO/VIDEO OUT on your VCR to AUDIO/VIDEO IN on your TV.
- 6** Using component video cables (not supplied), connect YP<sub>B</sub>P<sub>R</sub> OUT on your satellite receiver to YP<sub>B</sub>P<sub>R</sub> IN on your TV.
- 7** Connect AUDIO OUT on your satellite receiver to AUDIO IN on your TV.

## Connecting a Camcorder (for playback)

To connect your camcorder, you can use the Audio/Video inputs on either the front or rear panel of the TV. Using the audio/video cables (not supplied), connect AUDIO/VIDEO OUT on your camcorder to AUDIO/VIDEO IN on your TV.

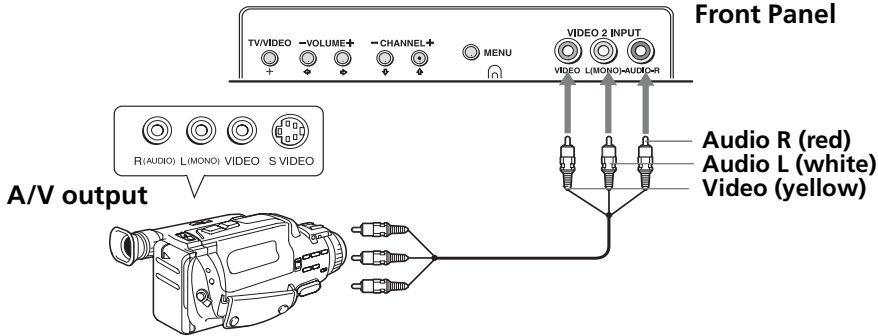

### Optional connection

- ❑ For better picture quality, use S VIDEO (located on the rear panel), instead of the yellow video cable. S VIDEO does not provide sound, so you still must connect the audio cables.

## Connecting for Video Tape Editing (VCR and Camcorder)

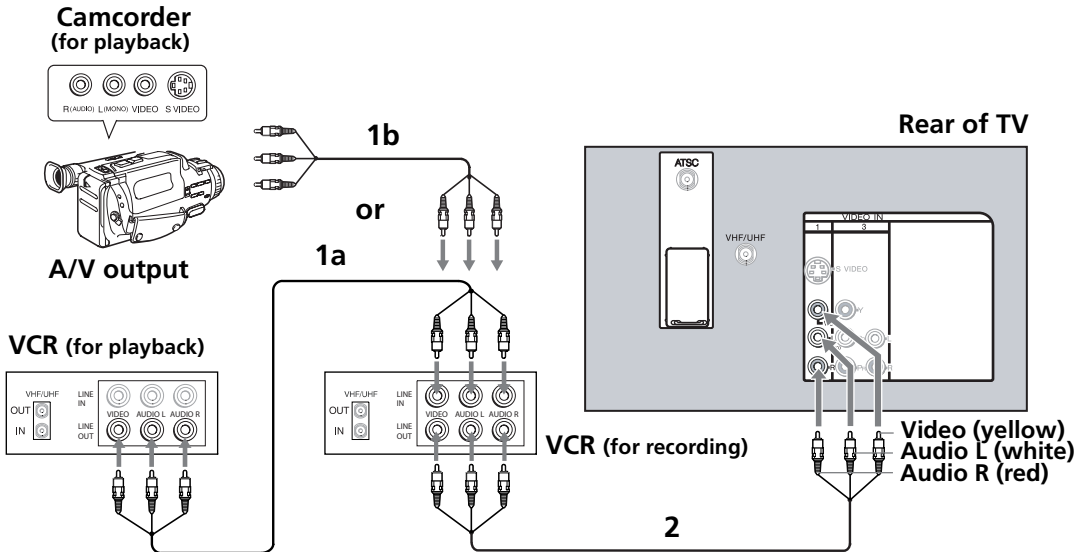

- 1** For video tape editing, connect the VCR to the following sources:

  - ❑ If you are connecting a VCR, use audio/video cables (not supplied) to connect AUDIO/VIDEO OUT on your first VCR to AUDIO/VIDEO IN on your second VCR (option 1a).
  - ❑ If you are connecting a camcorder, use audio/video cables (not supplied) to connect AUDIO/VIDEO OUT on your camcorder to AUDIO/VIDEO IN on your VCR (option 1b).
- 2** Using audio/video cables (not supplied), connect AUDIO/VIDEO OUT on the second VCR to AUDIO/VIDEO IN on your TV.

# Setting Up the TV

After you have finished connecting your TV, use Auto Program to set up your analog and digital channel lists. During Auto Program, the TV will automatically search for available channels and program receivable channels.

 After starting Auto Program, wait until the process is complete to avoid missing some channels that are available. To re-program receivable channels, run Auto Program again as described on page 22 (analog channels) and page 31 (digital channels).

- 1** Press the **POWER** button to turn on the TV.  
The Initial Setup screen appears.
- 2** Press the **CH+** button on the remote control or on the TV front panel to start Auto Program, or press the **CH-** button to exit.

 The Initial Setup screen appears each time you turn on the TV until you perform Auto Program.

Auto Program automatically creates a list of receivable analog channels. When completed, a screen prompts you to continue searching for digital channels.

Searching for digital channels may take 50 minutes or more to complete. A progress bar is displayed while the channel list is being created.

- 3** When Auto Program is finished, the lowest numbered channel is displayed.



## To run Auto Program again at a later time

- Use the Auto Program feature, using the TV's menus. For analog channels, see page 22. For digital channels, see page 31.

## To add digital channels

- Use the Digital Channels/Add feature, as described on page 31.

## To reset the TV to factory settings

- 1** Turn the TV on.
- 2** Hold down  on the remote control.
- 3** Press and release the **POWER** button on the TV front panel. The TV will turn itself off, then back on.
- 4** Release .

# Using the Digital Features













## Overview

This chapter describes how to use the features of your TV that are designed to work with digital channels.

## Tuning to a Digital Channel

This TV is equipped with a built-in digital tuner, which enables you to receive digital channels. In order to enjoy the digital features of this TV, you need to switch the TV between analog and digital tuning modes by pressing the  button on the remote control, or by switching between analog and digital tuning modes using the TV's Channel Mode menu option (see page 29).

### To directly tune to a digital channel:

- 1 If the TV is in analog tuning mode, press  on the remote control to enter digital tuning mode.
- 2 Press , , , press ,  again, and then .  
For example, to select subchannel 21.13, press ++++, and then press .

# Using the Digital Program Guide

The digital program guide lets you review program information and select digital channels.

The digital program guide cannot be displayed when: the TV is in analog tuning mode, when there are no digital channels available, when the TV is tuned to one of the video inputs, or when the Channel Fix option is set to anything other than Off (see page 22).

## To display the digital program guide:

**1** If the TV is in analog tuning mode, press the button on the remote control to switch to digital tuning mode.

You can also see the current tuning mode and switch between analog and digital tuning modes using the Channel Mode menu option (see page 29).

**2** Press . The digital program guide appears, with the currently selected program showing in the background.

The screenshot shows a digital program guide interface. At the top, it displays the program title "Make Way for Ducks!" and a description: "Series follows the aquatic misadventures of Henry and Riley, two wayward ducks on a unique mission." Below this, it shows "Time remaining: 1:26" and a "TV-G" rating. On the right side, it displays the channel number "C23.1" and the call letters "FAM". In the center, there is a list of channels with their corresponding call letters: 7 ABC, 10 DISC, 23.1 FAM, 36 TLC, 65 HIST, and 68 SHOW. The background of the interface shows a black and white image of two ducks swimming in water.

**Program title and description, time remaining, rating information, closed-caption availability, format, resolution, aspect ratio** — points to the top section of the interface.

**Channel number, call letters (if available)** — points to the "C23.1 FAM" text.

**Selectable channel list** — points to the list of channels on the left side.

Program information in the guide is provided by the broadcasters. As a result, it may sometimes include only the channel number, without a program title or description.

To Do This ...	Do This ...
Scroll through the channel list	Press  or .
Select the currently displayed channel and exit the guide	Press .
Display additional options	Press . See "Using Additional Digital Program Guide Options" on page 16.
Exit the Guide (without changing channels)	Press .

## Using Additional Digital Program Guide Options

Press **➔** while in the digital program guide's channel list to display the following options, which allow you to customize the settings of the program on the currently tuned channel.



Option	Description
Alternate Video (when available)	Each program has a main video stream (the video that you see when the channel is first tuned), and may have alternate video streams. This option allows you to switch among these alternate video streams.
Alternate Audio (when available)	Each program has a main audio stream (the audio that you hear when the channel is first tuned). This option allows you to switch among these alternate audio streams (e.g., for different languages).

## Using Digital Favorite Channels

The digital Favorite Channels feature lets you select programs from a list of up to 16 favorite digital channels that you specify. You can create a list using the Favorite Channels option in the Digital Channel menu (described on page 31).







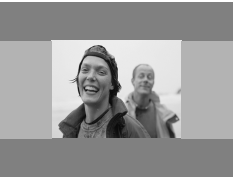
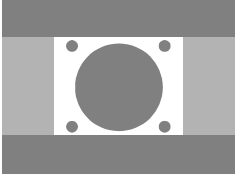

# Using the Screen Mode Feature

The Screen Mode feature is useful for adjusting a 16:9 (widescreen) program for optimal viewing on your TV's 4:3 aspect ratio screen. Using the Screen Mode feature, you can enlarge pictures so that they better fill the screen (enlarging the picture so that the black bars on the edges of the screen are clipped off).

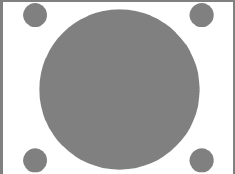
 The Screen Mode option is available only for digital 16:9 programming.

## Before using the Screen Mode feature

- If the TV is in analog tuning mode, press the  button to switch to digital tuning mode.

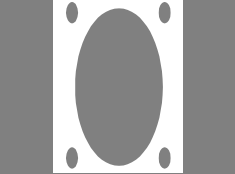

Example	Description
  <p data-bbox="310 685 350 711"><b>Full</b></p> <p data-bbox="315 729 337 755">↓</p>	<p data-bbox="460 499 915 720"><b>Full</b> displays the 16:9 program in its original aspect ratio. If the program was a 480i 4:3 program that was upconverted to 720p or 1080i (as shown at left), there will be black bars visible at the left, right, top, and bottom sides.</p> 
  <p data-bbox="299 951 360 977"><b>Zoom</b></p> <p data-bbox="315 994 337 1020">↓</p>	<p data-bbox="460 772 897 833"><b>Zoom</b> enlarges the picture uniformly. Some clipping may occur.</p> 
  <p data-bbox="232 1215 427 1241"><b>Horizontal Expand</b></p> <p data-bbox="315 1258 337 1284">↓</p>	<p data-bbox="460 1032 877 1128"><b>Horizontal Expand</b> stretches the picture horizontally. Some clipping may occur.</p> 
  <p data-bbox="245 1475 413 1501"><b>Vertical Expand</b></p>	<p data-bbox="460 1293 891 1354"><b>Vertical Expand</b> stretches the picture vertically. Some clipping may occur.</p> 

# Using the Analog Menus

## Overview

This chapter describes how to use the analog menu features of your TV.

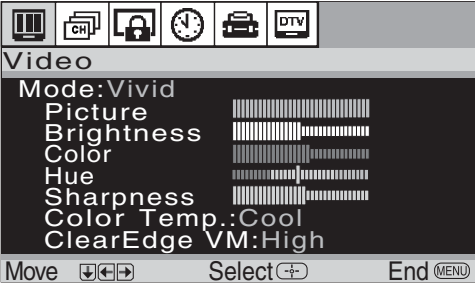
## Menu Descriptions

Analog Menu	Description
	<p><b>Video Menu</b> Adjust your picture settings. For details, see page 21.</p>
	<p><b>Channel Setup Menu</b> (Analog channels only): Customize your channel settings. For details, see page 22.</p>
	<p><b>Parental Control Menu</b> Set rating limits on your TV based on program rating or content. For details, see page 23.</p>



## Analog Menu

## Description

**Clock/Timers Menu**

Set the clock on your TV and program scheduled viewing using Timer 1 and Timer 2 (*timers work with analog channels only*).

For details, see page 27.

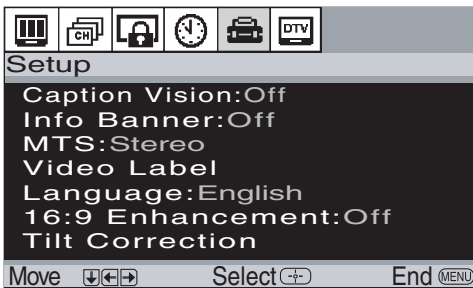
**Setup Menu**

(*Analog channels only*): Select analog closed captioning options (Caption Vision), display the name of the current program and its remaining time (Info Banner), select stereo, bilingual and mono programs (MTS), label video inputs, select menu language, enhance DVD picture resolution (16:9 Enhanced), and adjust tilt correction.

For details, see page 28.

**Digital Features Menu**

Access Digital Menu options and select analog or digital tuning modes.

For details, see page 29.

## Using the Remote Control to Display and Navigate the On-Screen Analog Menus

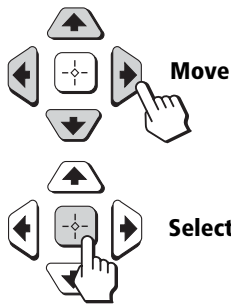
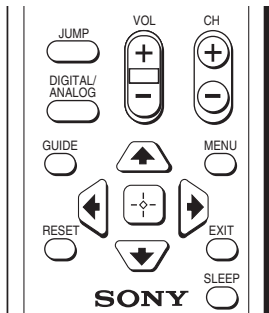

- 1 Press to display the on-screen analog menu.
- 2 Use the or buttons to highlight the desired menu icon. Press to select it.
- 3 Use the or buttons to scroll up and down through the features.
- 4 Follow the instructions on the screen.
- 5 Press to exit the menu.

Press once to display the on-screen menu, and press again to return to normal viewing. If no buttons are pressed, the menu closes automatically after about 90 seconds.

### To exit the analog menus

- Press (or .

### To display the digital menus

- See "Using the Remote Control to Display and Navigate the On-Screen Digital Menus" on page 30.

# Using the Video Menu

To access the Video Menu, use the following steps:

**To Display**



**To Select**



Press **↓** to highlight an option, then press .

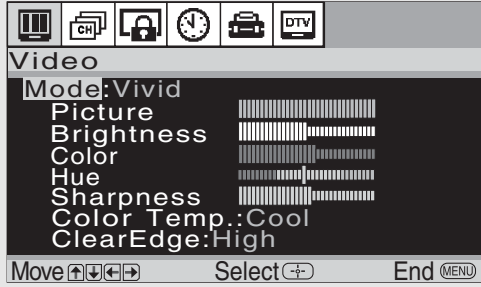





## Mode

*Customized picture viewing*

Use the **↑** or **↓** buttons to highlight one of the following options, then press  to select it.

- Vivid:** Select for enhanced picture contrast and sharpness.
- Standard:** Select for a standard picture.
- Movie:** Select for a finely detailed picture.
- Pro:** Select for natural picture and sharpness.

 Press  on the remote control to directly select picture modes (Vivid, Standard, Movie, Pro).

<b>Picture</b>	Press <b>←</b> to decrease the contrast. Press <b>→</b> to increase the contrast.
<b>Brightness</b>	Press <b>←</b> to darken the picture. Press <b>→</b> to brighten the picture.
<b>Color</b>	Press <b>←</b> to decrease color saturation. Press <b>→</b> to increase color saturation.
<b>Hue</b>	Press <b>←</b> to increase the red tones. Press <b>→</b> to increase the green tones.
<b>Sharpness</b>	Press <b>←</b> to soften the picture. Press <b>→</b> to sharpen the picture.
<b>Color Temp.</b> <i>White tint adjustment</i>	Use the <b>↑</b> or <b>↓</b> buttons to highlight one of the following options, then press  to select it. <ul style="list-style-type: none"> <li><b>Warm:</b> Gives white colors a red tint.</li> <li><b>Neutral:</b> Gives white colors a neutral tint.</li> <li><b>Cool:</b> Gives white colors a blue tint.</li> </ul>
<b>ClearEdge VM</b>	Sharpens picture definition to give objects a crisp, clean edge. Use the <b>↑</b> or <b>↓</b> buttons to highlight: High, Low, or Off, then press  to select it.

 Available only for KD-32FS170 and KD-36FS170 models.

## Using the Channel Setup Menu

To access the Channel Setup Menu, use the following steps:

**To Display**





**To Highlight**



**To Select**



Press  to highlight an option, then press .











### Favorite Channels

*Quick access to analog favorite channels*

*Applies to analog channels only. To set up favorite digital channels, see page 31.*

To set up your analog Favorite Channels list:

- 1 Use the  or  buttons to highlight the position (1-5) where you want to set a favorite channel, then press .
- 2 Use the  or  buttons to find the channel you want to add to your favorite channels.
- 3 Press  to select the channel. The TV will automatically change to the selected channel and assign it to the selected position (1-5).
- 4 Press  to return to the Channel Setup menu or press  to exit.

### Cable



Use the  or  buttons to highlight one of the following options, then press  to select it.

- On:** Select if you are receiving cable channels with a CATV cable.  
**Off:** Select if you are using a TV antenna.

 After changing the Cable setting the first time, you will need to run Auto Program. For analog channels, see page 22. For digital channels, see page 31.

### Channel Fix

*Not available when in digital tuning mode.*

Use the  or  buttons to highlight one of the following options, then press  to select it.

- Off:** Channel Fix is not set.
- 2-6:** “Fix” your TV’s channel setting to 2–6 (VHF/UHF input) and use the cable box or satellite receiver to change channels.
- Video 1:** Select from available video inputs when you have connected video equipment (e.g., a satellite receiver) and you want your TV fixed to it.

 You cannot use Favorite Channels, Cable, Channel Show/Hide, or Channel Label when Channel Fix is set.

### Auto Program

*Applies to analog channels only. To Auto Program digital channels, see page 31.*  
 Perform Auto Program whenever setting up your TV. Auto Program will search for available channels and program receivable channels.

**Channel Show/Hide**

*Applies to analog channels only. To Show/Hide digital channels, see page 31.*  
Use this feature after you run Auto Program to selectively show or hide channels.

- 1 Use the **▲** or **▼** buttons to highlight the position of the desired channel, then press **[+]**.
- 2 Use the **▲** or **▼** buttons to highlight **Shown** or **Hidden**, then press **[+]**.
- 3 Press **◀** to return to the Channel Setup Menu or press **EXIT** to exit.

 Press **CH +** or **CH -** to skip over channels that have been hidden. You can still use the **0-9** buttons to directly tune to hidden channels.

**Channel Label**

*Label up to 40 channels with their call letters*

*Applies to analog channels only. To label digital channels, see page 31.*

- 1 Press **[+]**, then use the **▲** or **▼** buttons until you reach the desired channel number.
- 2 Press **[+]** to activate the channel.
- 3 Press **▼** to highlight **Label**, then press **[+]**. Use the **▲** or **▼** buttons to display the first call letter or number of the label. Press **[+]** to select. Repeat this process until you finish selecting all the call letters.
- 4 When finished, press **[+]** to activate.
- 5 Press **◀** to return to the Channel Setup menu or press **EXIT** to exit.

**Using the Parental Control  Menu**

To access the Parental Control Menu, use the following steps:

**To Display****To Highlight ****To Select**

The Parental Control feature helps parents monitor what their children watch on television.

 Parental Control settings control analog and digital programs.

**To use the Parental Control Menu**

When you select the Parental Control menu, you are prompted to set a 4-digit password. You cannot access the Parent menu settings without this password.

- 1 Use the **0-9** buttons to enter a 4-digit password.
- 2 Confirm your password by entering it again.

 Keep this manual in a safe place. You need your password for any future access to the Parental Control menu. If you forget your password, see page 35.



# Parental Control

## Setting the Rating

You can change the Rating by selecting one of the Parental Lock options.

- 1 With **Lock** highlighted, press .

If you are not familiar with Parental Guideline rating system, use one of the following preset categories to simplify the rating selection: Child, Youth, Young Adult.

- 2 Use the  or  to highlight the desired rating and press .







Rating	TV will allow a maximum rating of
Off	No rating limit
Child	TV-Y, TV-G, G (U.S.), G, C (Canada)
Youth	TV-PG, PG (U.S.), 8 ans + (Canada)
Young Adult	TV-14, PG-13 (U.S.), 14+ (Canada)
Custom	Select to set more restrictive ratings (see next section)

## Changing your Password

- 1 Use the  or  buttons to highlight **Change Password** and press .
- 2 Follow steps 1 and 2 for “Using the Parental Control Menu” on page 23.



## Select a Country

Select U.S.A. to use US ratings (see pages 25-26) or select Canada to use Canadian ratings (see page 26). If you select a Country (U.S. or Canada) that is not where you live, the rating you select will not be activated.

- 1 Press  to highlight **Country**, then press .
- 2 Use the  or  to highlight the desired country and press .

## Information for Parents

### To view a program that exceeds the TV rating

- Press , then use the - buttons to enter your password.

 Entering your password to view a blocked program will temporarily turn **Lock** to Off. To reactivate your Lock settings, turn the TV off then back on; the TV will return to the settings that you have selected.

## Using the Custom Menu

Follow the instructions on the screen to make your custom settings. Select the country desired for your TV's rating limit. For more information see page 25 for (U.S. models) and page 26 for (Canadian models).

 Once you have blocked a rating or content, all higher ratings or content will be automatically blocked.

# United States: Selecting Custom Rating Options

For the United States, the Custom Rating menu includes the following options: Movie Rating, TV Rating, and Unrated. (For Canada, see page 26.)

## Movie Rating

This system defines the rating levels of movies shown in theaters and on prime cable channels.

Rating	Defined as
<b>G</b>	General audience
<b>PG</b>	Parental guidance suggested
<b>PG-13</b>	Parents strongly cautioned
<b>R</b>	Restricted
<b>NC-17</b>	No one 17 and under admitted
<b>X</b>	Adult audience only

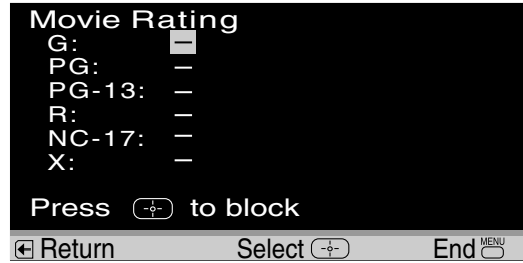

## TV Rating

The TV rating is divided into two groups: age-based and content-based.

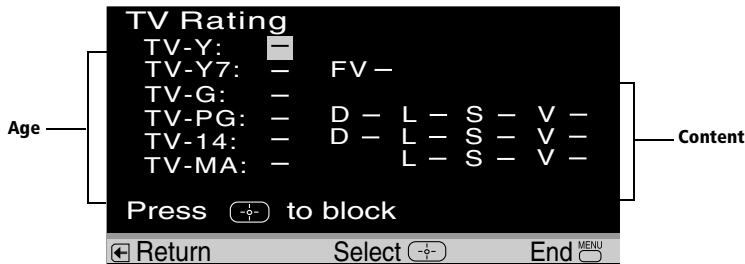

Age	Defined as
<b>TV-Y</b>	All children
<b>TV-Y7</b>	Directed to older children
<b>TV-G</b>	General audience
<b>TV-PG</b>	Parental guidance suggested
<b>TV-14</b>	Parents strongly cautioned
<b>TV-MA</b>	Mature audience only

Content	Defined as
<b>FV</b>	Fantasy violence
<b>D</b>	Suggestive dialogue
<b>L</b>	Strong language
<b>S</b>	Sexual situations
<b>V</b>	Violence

The content ratings will increase depending on the level of the age-based rating. For example, a program with a TV-PG V (Violence) rating may contain moderate violence, while a TV-14 V (Violence) rating may contain intense violence.

## Unrated

You have the option of blocking TV programs or movies that are not rated.

<b>Allow</b>	Allows all unrated programs
<b>Block</b>	Blocks all unrated programs



 If you choose to block unrated TV programs, please be aware that the following programs may be blocked: emergency broadcasts, political programs, pro, news, public service announcements, religious programs, and weather.

## Canada: Selecting Custom Rating Options

For Canada, the Custom Rating menu includes the following options: English Rating, French Rating, and U.S.A. Rating.

### English Rating

These ratings are for Canadian programs that are broadcast in English.

Rating	Defined as
<b>C</b>	Children
<b>C8+</b>	Children 8 years and older
<b>G</b>	General programming
<b>PG</b>	Parental guidance
<b>14+</b>	Viewers 14 and older
<b>18+</b>	Adult programming

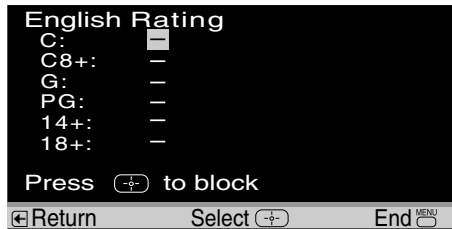

### French Rating

These ratings are for Canadian programs that are broadcast in French.

Rating	Defined as
<b>G</b>	General
<b>8 ans+</b>	Not recommended for younger children
<b>13 ans+</b>	Not recommended for children under age 13
<b>16 ans+</b>	Not recommended for ages under 16
<b>18 ans+</b>	This program is restricted to adults

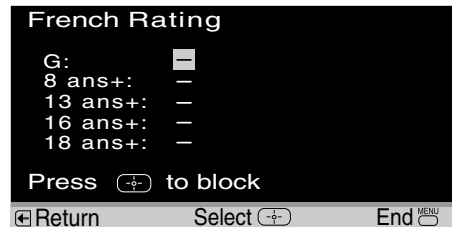

### U.S.A. Rating

For programs from the United States, see "TV Rating" on page 25.



## Using the Clock/Timers Menu

To access the Clock/Timers Menu, use the following steps:

**To Display**





**To Highlight** 



**To Select**









Press  to highlight an option, then press .



### Timer 1 Timer 2 Scheduled viewing





*Clock/Timers functions apply to analog channels only. You cannot set the Clock/Timers for digital channels.*

Use the timers to program your TV to turn on and off by day, time, duration, and channel. The timer duration is a maximum of six hours. When the channel is fixed, it is not necessary to set the channel.

- 1 Use the  or  buttons to highlight **Timer 1** or **Timer 2**, then press .
- 2 Use the  or  buttons to enter the desired day, start time, duration, and channel, then press . The timer status should be On when the Timer has been set, and the timer light on the front panel of the TV should be on.
- 3 Press  to exit the menu.

 Select Off to turn off the Timer. Your previous settings will be saved.

**Current Time** Set your TV to the current day and time. Press  to open the Current Time menu:

- 1 Use the  or  buttons to enter the correct day and time, then press .
- 2 Press  to exit the menu.

 You must set the Current Time before you can use Timer 1 or Timer 2.

 When you perform Auto Program, Timer 1 and Timer 2 settings will be cleared. Also, in the event of any loss of power, Current Time, Timer 1, and Timer 2 settings will be cleared.

## Using the Setup Menu

To access the Setup Menu, use the following steps:

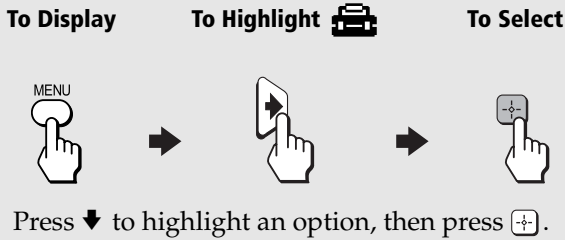

### Caption Vision

*Closed-Captioning*

*Applies to analog channels only. To set closed-caption options for digital channels, see page 32.*

Allows you to select from three closed-caption modes for programs that are broadcast with closed captioning.

Use the **↑** or **↓** buttons to highlight one of the following options, then press  to select it.

**Off:** Caption Vision is not activated.

**CC1, 2, 3, 4:** Displays printed dialog and sound effects of a program.

**Text1, 2, 3, 4:** Displays network/station information.

### Info Banner

Displays the name of the current program and its remaining time (if available) when you change the channel or press the **DISPLAY** button. Use the **↑** or **↓** buttons to highlight **On** or **Off**. Then press .

### MTS

*Multi-Channel TV Sound*

*Applies to analog channels only.*

Use the **↑** or **↓** buttons to highlight one of the following options, then press  to select it.

**Stereo:** Select when viewing a broadcast in stereo.

**Mono:** Select to reduce noise in areas of poor reception.

**Auto SAP:** Select to have the TV automatically switch to a Second Audio Program (SAP) when a signal is received.

### Video Label

*Label connected equipment*

Allows you to identify the video components connected to the TV: VCR, DVD, etc. When you press  to switch inputs, the Video Label appears on-screen.

**1** Press the **↑** or **↓** buttons to highlight the input you want to label and press .

**2** Press the **↑** or **↓** buttons to highlight a label and press .

**3** Press **←** to return to the Setup menu or press  to exit.



If you select Skip, your TV skips this input when you press the TV/VIDEO button.

### Language

Display all menus in the language of your choice.

Use the **↑** or **↓** buttons to select from one of the following options: **English**, **Español** (Spanish) and **Français** (French). Then press .

### 16:9

**Enhanced**

*Available only when the TV is displaying an external input, such as a DVD player.*

Provides enhanced picture resolution for wide-screen sources such as DVD.

### Tilt Correction





Use the **↑** or **↓** buttons to set the tilt of the picture from -5 to +5, then press  to activate.





Available only for KD-32FS170 and KD-36FS170 models.

# Using the Digital Features Menu



To access the Digital Features Menu, use the following steps:

<p><b>To Display</b></p> 	<p>→</p>	<p><b>To Highlight</b> </p> 	<p>→</p>	<p><b>To Select</b></p> 
--	----------	--	----------	---

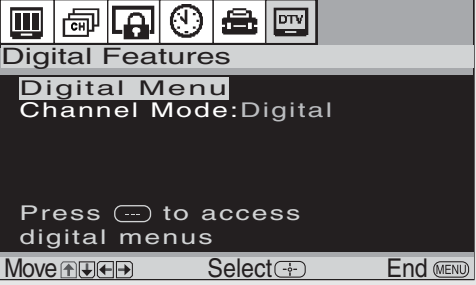
Press  to highlight an option, then press .



<b>Digital Menu</b>	Provides access to the Digital Channels and Digital Setup options. For details, see "Using the Digital Menus" on page 30.
<b>Channel Mode</b>	Enables you to switch between analog and digital tuning modes.
<b>Analog</b>	Selects analog tuning mode.
<b>Digital</b>	Selects digital tuning mode.

 Press the  button on the remote control to directly switch to analog or digital Channel Mode.

# Using the Digital Menus





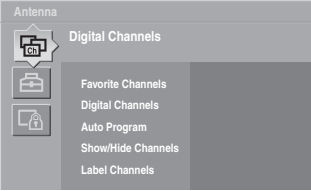
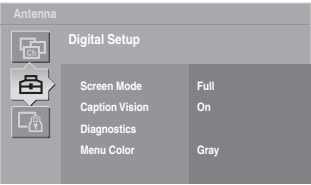
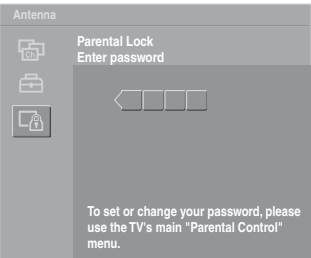

This chapter describes how to use the digital menu features of your TV.

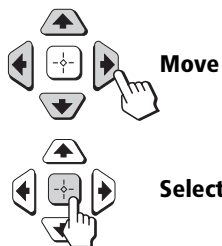
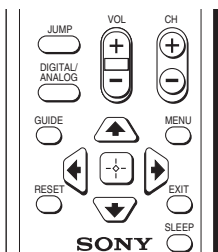
## Menu Descriptions

Digital Menu	Description
	<b>Digital Channels Menu</b> Select favorite digital channels; add, show, hide, and label digital channels.  For details, see page 31.
	<b>Digital Setup Menu</b> Provides settings for selecting various screen modes and for Caption Vision. Also includes diagnostics information and allows you to change the colors of the digital menus.  For details, see page 32.
	<b>Parental Lock Menu</b> This menu allows you to block programs containing downloaded digital ratings only.  For details, see page 34.

## Using the Remote Control to Display and Navigate the On-Screen Digital Menus



- 1 Press  to display the analog menu.
- 2 Press  to highlight the Digital Features menu icon  and then press . (For details, see “Using the Digital Features Menu” on page 29.)
- 3 Press  to highlight **Digital Menu** and then press .

 If the TV is in analog tuning mode, it will switch to digital tuning mode when displaying the digital menus.

### To exit the digital menus

- ❑ Press .

### To display the analog menu directly from within any digital menu

- ❑ Press .

# Using the Digital Channels Menu

To use the Digital Channels Menu, use the following steps:

**To Display**





**To Highlight**



**To Select**





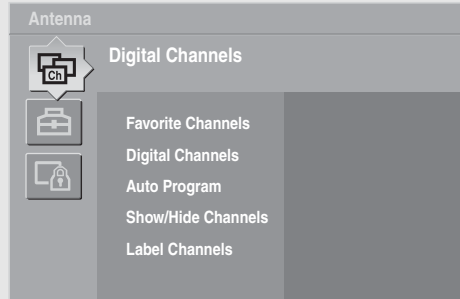



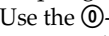

Press  to highlight an option, then press .



## **Favorite Channels**

*Applies to digital channels only. To set up analog channels, see page 22.*  
To set up digital channels in a Favorite Channels list:

- 1 Use the ,  and  buttons to enter the channel number that you want to assign to the Favorite Channel number. Press  to select that channel as a Favorite Channel.
- 2 To add more channels to your favorites list, repeat step 1.
- 3 To clear a Favorite Channel, press  or  to highlight the channel you want to clear. Press  and then press .

To use the digital Favorite Channels list, see page 16.

 You can also add Favorite Channels directly to the Favorite Channels list, as described on page 16.

## **Digital Channels**

*Applies to digital channels only.*  
**Add** Select to add digital channels.





## **Auto Program**

*Applies to digital channels only. To Auto Program analog channels, see page 22.*  
Automatically sets up the channel list on the TV for all receivable channels.

 Auto Program may take 50 minutes or more to complete. A progress bar will display the approximate progress of the Auto Program and Digital Channels/Add sequences.

## **Show/Hide Channels**





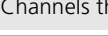



*Applies to digital channels only. To Show/Hide analog channels, see page 23.*  
Allows you to show or hide channels that appear when you use the **CH+/-** buttons to channel surf. Channels that are set to **Hidden** do not appear on the Program Guide's channel list, and are skipped when you use the **CH+/-** buttons.

- 1 Press  or  to highlight the channel that you want to show or hide. To move between the Major and Digital subchannel lists, press  or .
- 2 To change a channel's setting to **Shown** or **Hidden**, press .
- 3 To show or hide more channels, repeat steps 1 and 2.

 Channels that you set to **Hidden** can be accessed only with the .

## **Label Channels**

*Applies to digital channels only. To label analog channels, see page 23.*  
Allows you to assign labels (such as station call letters) to channel numbers.

- 1 Press  or  to scroll through the channel numbers. Then press  to select the channel number that you want to assign a label.
- 2 Press  or  to scroll through the label characters (A-Z, 0-9, etc.). Then press  to select the highlighted character.
- 3 Repeat to add characters to the label.
- 4 To assign labels to more channels, repeat steps 1-2.
- 5 Press  to return to the Channel Setup menu, or press  to exit the menus.

# Using the Digital Setup Menu

To use the Digital Setup Menu, use the following steps:

**To Display**





**To Highlight**



**To Select**



Press  to highlight an option, then press .

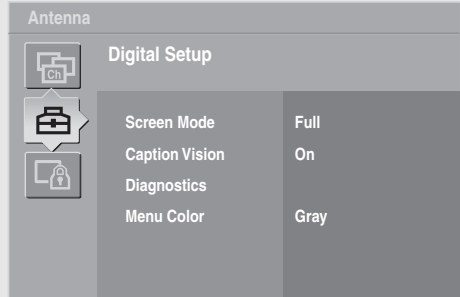

## Screen Mode

*Applies only to digital channels that have 16:9 or widescreen aspect ratio. You cannot use Screen Mode for analog channels.*

Enables you to change the picture size for digital channels.

Select from: **Full, Zoom, Horizontal Expand, Vertical Expand**. For details, see “Using the Screen Mode Feature” on page 17.

 In some cases, wide-screen programs will be shown in aspect ratios that require the display of bars at the top and bottom of your 16:9 screen. For more details, see page 36.

## Caption Vision

*Applies to digital channels only. To set closed-caption options for analog channels, see page 28.*

Allows you to select from several closed caption modes (for programs that are broadcast with closed captioning).

**On** Caption Vision is turned on.

**Off** Caption Vision is turned off.

**Program** Allows you to set additional Caption Vision options. See “Programming Caption Vision” on page 33.

## Diagnostics

Displays information about the currently tuned channel. For terrestrial digital signals, displays the strength of the signal to help you adjust your antenna to optimize signal reception.

## Menu Color

*Applies to digital menus only. You cannot set colors for analog menus.*

Enables you to select a specific color for the on-screen menus.

## Programming Caption Vision

*Applies to digital channels only. To set closed-caption options for analog channels, see page 28.*

If you selected the Program option under Caption Vision (page 32), you can change the following settings:

<b>Basic</b>	Allows you to select basic closed caption options (EIA-608).	
	<b>CC1, CC2, CC3, CC4</b>	Displays a printed version of the dialog or sound effects of a program. (Should be set to CC1 for most programs.)
	<b>Text1,Text2, Text3,Text4</b>	Displays network/station information presented using either half or the whole screen (if available). For closed captioning, set to CC1.
<b>Digital CC</b>	Allows you to set digital closed captioning to <b>Basic</b> (digital EIA-608) or <b>Advanced</b> (digital EIA-708).	
<b>Advanced</b>	Allows you to select advanced digital (EIA-708) closed caption options. Select from the available options.	
<b>Advanced Settings</b>	Allows you to make additional settings for digital (EIA-708) closed caption options.	
	<b>As Broadcast</b>	
	<b>Small Text</b>	
	<b>Large Text</b>	
	<b>Custom ...</b>	Allows you to customize the following settings:
	<b>Character Size</b>	<b>Small, Standard, Large</b>
	<b>Character Style</b>	<b>Style 1-7</b>
	<b>Character Color</b>	<b>Color 1-8</b>
<b>Character Opacity</b>	<b>Solid, Translucent</b>	
<b>Background Color</b>	<b>None, Color 1-8</b>	
<b>Background Opacity</b>	<b>Solid, Translucent</b>	

# Using the Parental Lock Menu

The Parental Lock Menu allows you to set up the TV to block programs according to their content and rating levels.

To access the Parental Lock Menu, follow these steps:



Use 0-9 buttons on the remote control to enter a four digit password.

To change settings, press . Press to confirm the selection.

To exit the Menu, press EXIT.

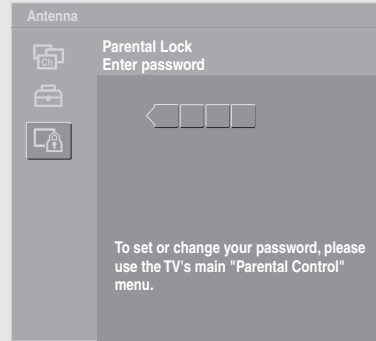

You need your password for any future access into the Parental Lock Setting. If you lose your password, see "Lost password" on page 35.

## Parental Lock (When available)

The Parental Lock option in the Parental Control Menu allows you to set up the TV to block digital programs that contain digital ratings.

The setting is only available if digital ratings have been downloaded by your TV and ratings have been set for U.S.A. in the Parental Control Menu (see page 25).

<b>Advanced Ratings</b>	<b>Off</b>	Turn Parental Lock off. No programs that contain downloadable ratings are blocked from viewing.
	<b>Custom...</b>	Select to block programs based on downloadable ratings.
	<b>Clear All</b>	Select to clear the entire downloadable rating system.

This action will delete the current Digital Rating menu and the menu will no longer be available until the TV is tuned to a channel that contains downloadable ratings.

To block analog programs, please use the Parent option within the TV's main Parental Control Menu on page 23.





# Other Information

## Troubleshooting

If you have a problem with your TV, try the suggestions below. If the problem persists, see “Contacting Sony” at the end of this section.

### General

Problem	Possible Remedies
<b>I want to reset the TV to the factory settings</b>	<input type="checkbox"/> Turn on the TV. While holding down the  button on the remote control, press the <b>POWER</b> button on the TV front panel. The TV will turn itself off, then back on again. Release the  button.
<b>The TV is dirty</b>	<input type="checkbox"/> Clean the TV with a soft dry cloth. Never use strong solvents such as thinner or benzene, which might damage the finish of the cabinet.
<b>I lost the parental control password</b>	<input type="checkbox"/> In the password screen in the analog Parent Control Menu, enter the following master password: <b>4357</b> . After using the master password, you must create a new password. You cannot use the master to unlock currently blocked channels.
<b>There is a black box on the screen</b>	<input type="checkbox"/> You have selected a text option in the Setup menu (page 28) and no text is available. To turn off this feature, select Off in the Caption Vision option. If you were trying to select closed captioning, select CC1-4 instead of Text1-4.
<b>There was a blackout or power outage, and now the TV won't turn on and the timer LED is flashing</b>	<input type="checkbox"/> Press the <b>POWER</b> button on your remote control or on the TV front panel. If the problem persists, see “Contacting Sony” on page 37.
<b>I can't connect the DVD player using component video outputs (YPbPr)</b>	<input type="checkbox"/> You must set up your DVD player before you can connect it using component video outputs (YPbPr). Disconnect the DVD player and set it up, referring to the DVD manual for instructions. Then, connect it to the TV again following the instructions on page 7.

## Remote Control

Problem	Possible Remedies
<b>I cannot operate the remote control</b>	<ul style="list-style-type: none"> <li><input type="checkbox"/> Check the orientation of the batteries.</li> <li><input type="checkbox"/> Batteries could be weak. Replace them (page 2).</li> <li><input type="checkbox"/> Move the TV three to four feet away from fluorescent lights.</li> </ul>
<b>I cannot change channels with the remote control</b>	<ul style="list-style-type: none"> <li><input type="checkbox"/> Make sure you have not inadvertently switched your TV from the channel 3 or 4 setting if you are using another device to change channels.</li> </ul>
<b>I lost the remote control</b>	<ul style="list-style-type: none"> <li><input type="checkbox"/> You can use the front panel controls to access your menus, change channels, adjust the volume, or change video inputs (page 2). Contact your nearest Sony Dealer to order a replacement. To find out the nearest dealer, please call our Sony Direct Accessory and Part Center at 1-800-488-7669 (U.S. residents only).</li> </ul>

## Video

Problem	Possible Remedies
<b>No picture, no sound</b>	<ul style="list-style-type: none"> <li><input type="checkbox"/> Make sure the power cord is plugged in.</li> <li><input type="checkbox"/> If a red light flashes on the front of your TV for more than a few minutes, disconnect and reconnect the power cord. If the problem continues, call your local service center.</li> <li><input type="checkbox"/> Check the TV/VIDEO setting. When watching TV, set it to TV; when watching video equipment, set it to VIDEO 1, 2, 3 or 4.</li> <li><input type="checkbox"/> Make sure you have inserted the batteries correctly into the remote control (page 2).</li> <li><input type="checkbox"/> Try another channel to rule out station trouble.</li> </ul>
<b>Poor or no picture, good sound</b>	<ul style="list-style-type: none"> <li><input type="checkbox"/> Adjust the <b>Picture</b> setting in the Video Menu (page 21).</li> <li><input type="checkbox"/> Adjust the <b>Brightness</b> setting in the Video Menu (page 21).</li> <li><input type="checkbox"/> Check the antenna and/or cable connections (page 6).</li> </ul>
<b>No color</b>	<ul style="list-style-type: none"> <li><input type="checkbox"/> Adjust the <b>Color</b> setting in the Video Menu (page 21).</li> </ul>
<b>Snow on the screen</b>	<ul style="list-style-type: none"> <li><input type="checkbox"/> Check the <b>Cable</b> setting in the Channel Setup Menu (page 22).</li> <li><input type="checkbox"/> Check the antenna and/or cable connections (page 6).</li> <li><input type="checkbox"/> Make sure the channel selected is currently broadcasting.</li> </ul>
<b>Dotted lines or stripes</b>	<ul style="list-style-type: none"> <li><input type="checkbox"/> Adjust the antenna.</li> <li><input type="checkbox"/> Move the TV away from other electronic equipment. Some electronic equipment creates electrical noise, which can interfere with TV reception.</li> </ul>
<b>Double images or ghosts</b>	<ul style="list-style-type: none"> <li><input type="checkbox"/> Check your outdoor antenna or call your cable service.</li> </ul>
<b>Bars appear at the top and bottom of the screen</b>	<ul style="list-style-type: none"> <li><input type="checkbox"/> Some wide-screen programs are filmed in aspect ratios that are greater than 16:9, such as 2.35:1. (This is especially common with theatrical releases). Your TV will show these programs with bars at the top and bottom of the screen. For more details, check the documentation that came with your DVD (or contact your program provider).</li> </ul>

Problem	Possible Remedies
<b>Cannot cycle through the other video equipment connected to the TV</b>	<ul style="list-style-type: none"> <li>❑ Be sure the <b>Video Label</b> option is not set to <b>Skip</b> (see page 28).</li> </ul>
<b>Screen Mode feature does not function</b>	<ul style="list-style-type: none"> <li>❑ Screen Mode is available only for digital 16:9 programming in digital tuning mode. See page 17 for details.</li> </ul>
<b>VIDEO 3 input problems</b>	<ul style="list-style-type: none"> <li>❑ VIDEO 3 inputs accept only 480i signal formats. Be sure the connected device is not set to output a format 480p or higher.</li> </ul>

## Audio

Problem	Possible Remedies
<b>Good picture, no sound</b>	<ul style="list-style-type: none"> <li>❑ Press  so that Muting disappears from the screen. Your TV may be set to <b>Auto SAP</b> in the MTS option within the Setup Menu.</li> <li>❑ Press <b>VOL+</b> to adjust your TV's volume.</li> </ul>
<b>Low or no audio (TV and cable box)</b>	<ul style="list-style-type: none"> <li>❑ Some cable boxes have volume level controls. Check and see if your cable box remote has a volume control.</li> </ul>

## Channels

Problem	Possible Remedies
<b>I cannot receive higher number channels (UHF) when using an antenna</b>	<ul style="list-style-type: none"> <li>❑ Make sure <b>Cable</b> is set to Off in the Channel Setup Menu (page 22).</li> <li>❑ Perform Auto Program to add channels that are not presently in memory (page 13).</li> </ul>
<b>Cable stations don't seem to work</b>	<ul style="list-style-type: none"> <li>❑ Make sure <b>Cable</b> is set to On in the Channel Setup Menu (page 22).</li> <li>❑ Perform Auto Program to add channels that are not presently in memory (page 13).</li> </ul>
<b>I have no digital channels</b>	<ul style="list-style-type: none"> <li>❑ You may not have any digital channels available. Try running the Auto Program feature to search for digital channels (see page 31). If there are none available, press the  button to switch to analog mode.</li> </ul>

## Contacting Sony

Before calling our Customer Information Services Center or visiting our website, reset the TV to factory settings (see page 13). Please have your TV serial number ready. The number is located on the rear of your TV and on the front cover of this manual.

Our Customer Information Services Center phone number is 1-800-222-SONY (7669) (US residents only) or 1-877-899-SONY (7669) (Canadian residents only). Our website is <http://www.sony.com/TVsupport>.

# Specifications

## For all models (except as noted)

Television system	NTSC	American TV Standard
	ATSC (8VSB terrestrial)	ATSC compliant 8VSB
Channel coverage	Terrestrial (analog)	2-69
	Cable TV (analog)	1-125
	Terrestrial (digital)	2-69
Antenna	75-ohm external antenna terminal for VHF/UHF	
Picture tube	FD Trinitron® tube	
Power requirements	120V, 60 Hz	
Supplied accessories	2 Size AA batteries 1 Remote Control RM-YD006	
Inputs	1 video, 1 audio (front) 1 video, 1 audio (rear) 1 S VIDEO 1 RF 1 ATSC 1 YPbPr (480i only), 1 audio	
Optional accessories	TV Stand: SU-27FS2 for KD-27FS170, SU-32FS2 for KD-32FS170, SU-36FS2 for KD-36FS170	

### KD-27FS170

Screen size	Visible screen size: 685.8 mm (27 inches) measured diagonally Actual screen size: 736.6 mm (29 inches) measured diagonally	
Speaker output	5 W x 2	
Power consumption	130 W Less than 1 W in standby	
Dimensions (W/H/D)	768 x 590 x 497 mm (30 1/4 x 23 1/4 x 19 5/8 inches)	
Mass	44.5 kg (98 lbs)	

### KD-32FS170

Screen size	Visible screen size: 803 mm (32 inches) measured diagonally Actual screen size: 863.6 mm (34 inches) measured diagonally	
Speaker output	5 W x 2	
Power consumption	160 W Less than 1 W in standby	
Dimensions (W/H/D)	898 x 696 x 576 mm (35 3/8 x 27 3/8 x 22 5/8 inches)	
Mass	72 kg (158.5 lbs)	

### KD-36FS170

Screen size	Visible screen size: 911 mm (36 inches) measured diagonally Actual screen size: 965.2 mm (38 inches) measured diagonally	
Speaker output	5 W x 2	
Power consumption	160 W Less than 1 W in standby	
Dimensions (W/H/D)	985 x 776 x 633 mm (38 3/4 x 30 1/2 x 24 7/8 inches)	
Mass	98 kg (215.5 lbs)	

*Design and specifications are subject to change without notice.*

# Index

0-9 buttons **14**  
16:9 Enhanced **28**

## A

Alternate Audio **16**  
Alternate Video **16**  
Auto Program **13, 22, 31**

## B

Brightness **21**

## C

Cable, setting **22**  
Caption Vision **28, 32, 33**  
Channel Fix **22**  
Channel Label **23**  
Channel Mode, switching **29**  
Channel Show/Hide **23**  
ClearEdge VM **21**  
closed caption modes (see Caption Vision)  
Color Temperature **21**  
Color, setting **21**  
Connections  
    Cable and antenna **6**  
    Connecting a Camcorder **12**  
    DVD Player using Component Video **7**  
    DVD Player using Composite Video **7**  
    TV and Cable Box **9**  
    TV and Satellite Receiver **10**  
    TV and VCR **8**  
    TV, VCR, and Satellite Receiver using  
        Component Video **11**

Current Time **27**

## D

Diagnostics **32**  
Digital Menu **29**  
Digital Menus, exiting **30**  
Digital Menus, navigating **30**

## F

Favorite Channels **16, 22**  
Features **1**  
Front Panel **2**

## G

GUIDE button **15**

## H

Horizontal Expand (Screen Mode) **17**

## I

Info Banner **28**

## L

Label Analog Channels **22, 23**  
Label Channels **31**  
Label Digital Channels **31**  
Language **28**

## M

Menu Color **32**  
Menus  
    Channel **22**  
    Clock/Timers **27**  
    Digital Channels **31**  
    Digital Features **29**  
    Digital Setup **32**  
    Parental Control **23**  
    Parental Lock **34**  
    Setup **28**  
    Video **21**  
Mode  
    Movie **21**  
    Pro **21**  
    Standard **21**  
    Vivid **21**

MTS  
    Auto SAP **28**  
    Mono **28**  
    Stereo **28**

## P

Parental Control **24**  
Picture **21**  
Program Guide **15**

## R

Rear Panel **5**  
Remote Control  
    described **3**  
    Inserting batteries **2**

## S

Screen Mode **17, 32, 37**  
Setting the Rating  
    English Rating **26**  
    French Rating **26**  
    Movie Rating **25**  
    TV Rating **25**  
    U.S.A. Rating **26**  
    Unrated **26**  
Sharpness **21**  
Show/Hide Channels **31**  
Skip **37**  
SLEEP **4**  
Specifications **38**

## T

Tilt Correction **28**  
Timer 1 and Timer 2 **27**  
Troubleshooting **35**

## V

Vertical Expand (Screen Mode) **17**  
Video Label **28, 37**







2670362211

Sony Corporation

<http://www.sony.net>

Printed in U.S.A.