

# EMLOCKS

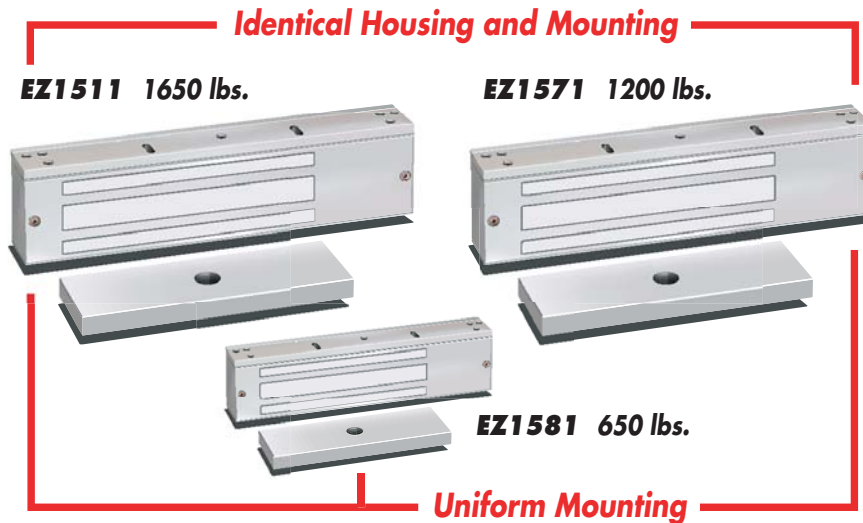

## New EMLock Design

- Interchangeable & Upgradeable Modular Assemblies
- Uniform Design & Installation
- Identical Housing, Template & Accessories - \*(1650 lb/1200 lb locks)
- Lifetime Serviceability
- EZ Mount Assembly

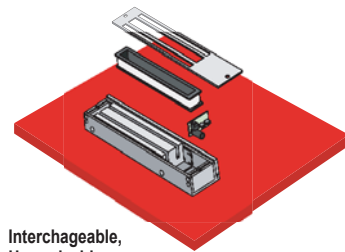

Interchangeable,  
Upgradeable,  
Modular Assemblies

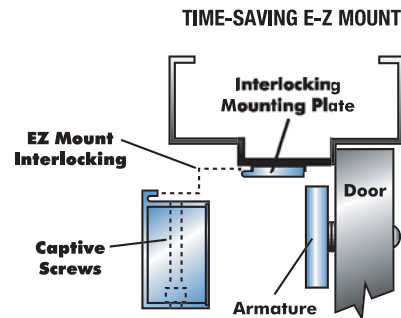

Request your FREE EMLock CD presentation online:

[www.sdsecurity.com](http://www.sdsecurity.com)



ISO 9001-2000  
FM 52705



CSFM  
Listed

MEA  
Listed



Manufacturers of Premium  
Grade Access Hardware

Box 6219 • Westlake Village, CA 91359-6219  
805.494.0622 FAX: 805.494.8861

**Uniform Design and Installation of all Models**



**Distributor and Installer Flexibility**

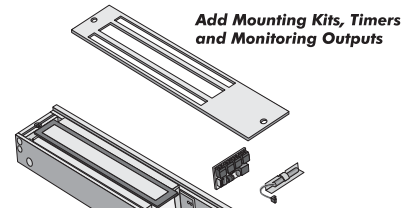

The modular design permits the addition of optional features, enabling standard locks to conform to several applications.

**Lifetime Serviceability and Upgradeability**

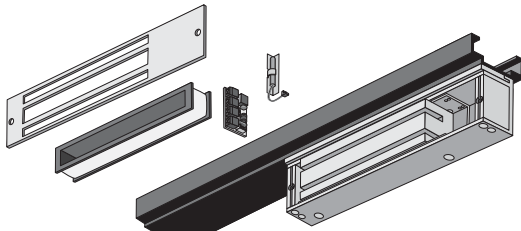

Upgrades and service without removing the lock from the frame eliminates lock replacement lead time and labor

**Interlocking EZ Mount Assembly**

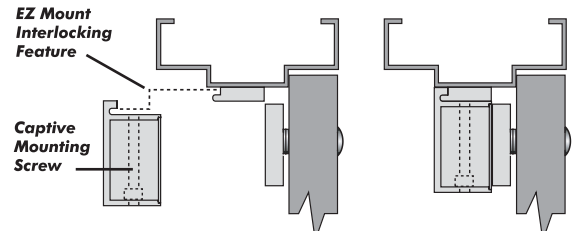

View the animated presentation and see how easy SDC EmLock installation is at [www.sdcsecurity.com](http://www.sdcsecurity.com)

**Specifications**

**GK**

**1510 Series Grade 1  
1650 lb / 748 Kg Holding Force**





**Electrical Specifications**

**Voltage:** 12/24VDC Voltage Sensing Input  
**Single:** 350mA @ 24VDC; 670mA @ 12VDC  
**Double:** 700mA @ 24VDC; 1.34mA @ 12VDC

**Mechanical Specifications**

**Single:** 11" L x 2.75" H x 1.562" D  
(279.4 x 69.9 x 39.7 mm)  
**Double:** 22" L x 2.75" H x 1.562" D  
(558.8 x 69.9 x 39.7 mm)

**Common Configurations (Alum. Finish)**

1511V	Single EmLock	
1511V-DPS	Door Sensor	
1511V-BA	Bond Sensor	
1511V-AT	Relock Timer	
1511V-BADPS	Door/Bond Sensor	
1511V-TJ1V	Top Jamb kit	
1511V-HDB1V	Glass Door kit	
1512V	Double EmLock	
1512V-2DPS	2 Door Sensor	
1512V-2BA	2 Bond Sensor	
1512V-AT	Timer	
1512V-TJ2V	Top Jamb kit	
1512V-HDB2V	Glass Door kit	

**1570 Series Grade 2  
1200 lb / 544 Kg Holding Force  
Low Power Consumption**





**Electrical Specifications**

**Voltage:** 12/24VDC Voltage Sensing Input  
**Single:** 125mA @ 24VDC; 250mA @ 12VDC  
**Double:** 250mA @ 24VDC; 500mA @ 12VDC

**Mechanical Specifications**

**Single:** 11" L x 2.75" H x 1.562" D  
(279.4 x 69.9 x 39.7 mm)  
**Double:** 22" L x 2.75" H x 1.562" D  
(558.8 x 69.9 x 39.7 mm)

**Common Configurations (Alum. Finish)**

1571V	Single EmLock	
1571V-DPS	Door Sensor	
1571V-BA	Bond Sensor	
1571V-AT	Relock Timer	
1571V-BADPS	Door/Bond Sensor	
1571V-TJ1V	Top Jamb kit	
1571V-HDB1V	Glass Door kit	
1572V	Double EmLock	
1572V-2DPS	2 Door Sensor	
1572V-2BA	2 Bond Sensor	
1572V-AT	Timer	
1572V-TJ2V	Top Jamb kit	
1572V-HDB2V	Glass Door kit	

**1580 Series Grade 3  
650 lb / 295 Kg Holding Force**



**Electrical Specifications**

**Voltage:** 12/24VDC Voltage Sensing Input  
**Single:** 220mA @ 24VDC; 440mA @ 12VDC  
**Double:** 440mA @ 24VDC; 880mA @ 12VDC

**Mechanical Specifications**

**Single:** 8.75" L x 2.125" H x 1.25" D  
(222.2 x 54 x 31.8 mm)  
**Double:** 17.5" L x 2.125" H x 1.25" D  
(444.5 x 54 x 31.8 mm)

**Common Configurations (Alum. Finish)**

1581V	Single EmLock	
1581V-DPS	Door Sensor	
1581V-BA	Bond Sensor	
1581V-BADPS	Door/Bond Sensor	
1581V-TJ81V	Top Jamb kit	
1581V-HDB1V	Glass Door kit	
1582V	Double EmLock	
1582V-2DPS	2 Door Sensor	
1582V-2BA	2 Bond Sensor	
1582V-TJ82V	Top Jamb kit	
1582V-HDB2V	Glass Door kit	

**Listings and Performance Specifications**

**GK**

**UL Listed** U.S./Canada: GWXT Auxiliary Locks, CVXJ Burglary Resistant Electrically Operated Door Lock  
**UL10C** Position Positive Pressure Compliant  
**ANSI/BHMA A156.23:** 1510 - Grade 1; 1570 - Grade 2; 1580 Grade 3  
**BHMA Certified Holding Force:** 1510 - Grade 1; 1570 - Grade 2; 1580 Grade 3

**CSFM** California State Fire Marshal Listed 3774-0324:100  
**MEA** City of New York 61-95-E  
**UBC** Classified in accordance with Uniform Building Code standard 7-2 "Fire Test for Door Assemblies"

**1 EMLOCK MODELS**     **GK**

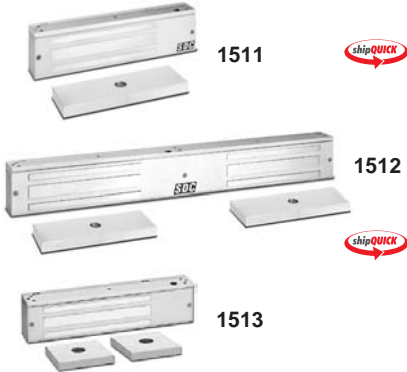

**Grade 1**  
**1650 lb / 748 Kg Holding Force**

1511 Single Emlock  
1512 Double Emlock  
1513 Single Emlock, split armature for pair of doors



**Grade 2**  
**1200 lb / 544 Kg Holding Force**

1571 Single Emlock  
1572 Double Emlock  
1573 Single Emlock, split armature for pair of doors



**Grade 3**  
**650 lb / 295 Kg Holding Force**

1581 Single Emlock  
1582 Double Emlock

**2 FINISHES**     **GK**

**Anodized Finishes**  
V 628 Aluminum (Standard) No Charge  
X 313 Dark Bronze  
Y 335 Black

**Plated Finishes**  
C 605 Bright Brass      G 612 Satin Bronze  
D 606 Dark Bronze      P 625 Bright Chrome  
F 611 Bright Bronze      Q 626 Satin Chrome

**3 OPTIONAL INPUTS & OUTPUT**     **GK**

See Modular Program price list when ordering separately for field upgrades. Different part numbers and pricing apply.

- AT Adjustable Timer** - Built in field adj. 0-30 sec. relock delay. **Specify one for single or double EmLocks** (not available with 1580 series).
- DPS Door Position Sensor** - Indicates door open and door closed. SPDT Dry, 250 mA @ 30VDC. **Specify (2) for double EmLocks**
- BA Magnetic Bond Sensor** - Indicates locked with full holding power and unlocked, low holding power, low voltage, tampering and obstruction between armature and magnetic core. **Specify (2) for double EmLocks**
  - 1510 & 1570 Series: SPDT Dry, 250 mA @ 30VDC.
  - 1580 Series: SPST N.O., Dry, 250 mA @ 30VDC.
- L3 Tri-color status LED indicator** - Field selectable Red, Green, Amber.
  - Indicates lock energized when wired to lock input.
  - Indicates de-energized/unlocked or "Enter/Go" when wired to built-in TD Module
  - Indicates energized and de-energized or "Enter/Go" when wired to access control auxiliary output.
  - Indicates door is closed and locked and door is unlocked when wired to BA.
- ATS Anti-Tamper Sensor** - Indicates access cover removal. SPDT Dry, 1 Amp @ 30VDC



Over 100 SDC products are available for shipment the same day or by the next business day. End users and installers are encouraged to use the shipQUICK Inventory list so you know first hand which SDC products your SDC distributor can expedite for you. Request a shipQUICK Inventory through our customer service staff or download a copy directly from the SDC website.

**SDC SECURITY DOOR CONTROLS**  
3580 Willow Lane • Westlake Village, CA 91361  
www.sdcsecurity.com



**4 TOP JAMB MOUNTING BRACKETS** **GK**

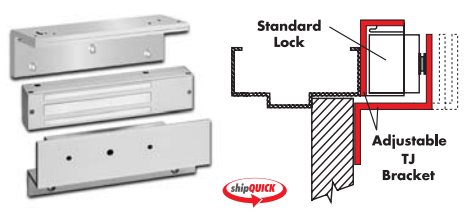

**Kits for 1200 lb and 1650 lb locks**  
 TJ1 Single  
 TJ2 Double

**Special Anodized Finish:** Single TJ  
 Double TJ

**Special Plated Finish:** Single TJ  
 Double TJ

**Kits for 650 lb locks**  
 TJ81 Single  
 TJ82 Double

TJ1V indicates standard aluminum

See page 20 Section 2 for special finish designation.

**5 UNIVERSAL GLASS DOOR MOUNTING KIT** **GK**

- Universal glass door kits are compatible with lock models, except 1513 and 1573
- Field adjustable for 1/2", 5/8" and 3/4" all glass Herculite doors

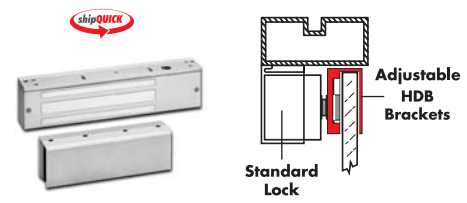

**Kits for 1511, 1571, 1581**  
 HDB1 Single

**Special Anodized Finish:**

**Special Plated Finish:**

**Aluminum Standard:** Example - HDB1V  
 See page 20 Section 2 for special finish designation.

**Kits for 1512, 1572, 1582**  
 HDB2 Double, 2 single kits

**Special Anodized Finish:**

**Special Plated Finish:**

**6 ARCHITECTURAL HOUSINGS** **GK**

HORIZONTAL HOUSING			VERTICAL HOUSING		
1511	V	36	1512	V	V82



**Full Width Housings** - appear as part of the frame to provide a superior architectural appearance.  
**Vertical Housings** - Side jamb mount, accommodates two 1571 or two 1511 EmLocks providing 2400 or 3300 lbs of holding force.  
**Compatible with Models:** 1511, 1512, 1571, 1572 with or without HDB kits.  
 Specify housings with your EmLocks.

**Single Door Housings**  
 30 30"  
 36 36"  
 40 40"  
 48 48"

**Double Door Housings**  
 60 60"  
 72 72"  
 84 84"  
 96 96"

**Vertical Housings**  
 82 84" high opening  
 CV\_\_\_ Custom, Specify Length

CH\_\_\_ Custom, Specify Length

CH\_\_\_ Custom, Specify Length

**Aluminum Standard**  
 Example: 1511V30

**Special Finishes**  
 See page 20 Section 2 for special finish designation and finish price.

**UNIVERSAL HEADER BRACKET** **GK**

Used in lieu of angle brackets, Universal Header Brackets provides a faster mounting solution, saving time and labor costs for several EmLock models. Reduce potential for mis-sized and misaligned mounting holes, broken taps, removal of broken taps. Combined with interlocking E-Z mount assembly, save up to a half days labor with the installation of 12 locks.

**Features**

- Solid 1" bar provides higher security and superior aesthetics.
- Machined wire chase provides concealed and secure wiring.
- Multiple predrilled and tapped mounting holes to accommodate the use of several different locks on either 4" or 4.5" aluminum frames

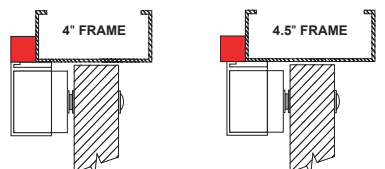

**Bracket for 1511, 1513, 1571, 1573**  
 UB11 1" x 1" x 11"

**Bracket for 1512, 1572**  
 UB12 1" x 1" x 22"

**Aluminum Standard**  
 Example: UB1V

**Special Finishes**  
 See page 22 for special finish designation

