

UHF RFID System V780 Series

3 in 1 UHF RFID System: Antenna, Amplifier & Controller

- Conforms to ISO/IEC 18000-63: 2013
- Long range and stable communications
- Reader/writer with integrated antenna
- Communications status visualized by LED indicators
- Ethernet (Modbus TCP, EtherNet/IP™) as a standard feature
- Simple and easy to use



 Refer to the *Safety Precautions and Precautions for Correct Use* in the User's Manual.

Ordering Information

Reader/Writer

Standard Reader/Writers

Appearance	Size (mm)	Network	Applicable countries *1	Model
	250 × 250 × 70	Modbus/TCP base (TCP/IP)	Japan	V780-HMD68-ETN-JP
			Korea	V780-HMD68-ETN-KR
			China	V780-HMD68-ETN-CN
			Taiwan	V780-HMD68-ETN-TW
			India	V780-HMD68-ETN-IN
			Indonesia	V780-HMD68-ETN-ID
			Malaysia	V780-HMD68-ETN-MY
			Singapore and Thailand	V780-HMD68-ETN-SG
			Under RE direct.	V780-HMD68-ETN-EU
			Russia	V780-HMD68-ETN-RU
			United States and Canada	V780-HMD68-ETN-US
			Mexico	V780-HMD68-ETN-MX
		EtherNet/IP	Japan	V780-HMD68-EIP-JP
			Korea	V780-HMD68-EIP-KR
			China	V780-HMD68-EIP-CN
			Taiwan	V780-HMD68-EIP-TW
			India	V780-HMD68-EIP-IN
			Indonesia	V780-HMD68-EIP-ID
			Malaysia	V780-HMD68-EIP-MY
			Under RE direct.	V780-HMD68-EIP-EU
			Russia	V780-HMD68-EIP-RU
			United States and Canada	V780-HMD68-EIP-US
			Mexico	V780-HMD68-EIP-MX

Slave Reader/Writers

Appearance	Size (mm)	Network	Applicable countries *1	Model
	250 × 250 × 70	— (For Multi-Reader/Writer function *2)	Japan	V780-HMD68-ETN-JP-S
			Korea	V780-HMD68-ETN-KR-S
			China	V780-HMD68-ETN-CN-S
			Taiwan	V780-HMD68-ETN-TW-S
			India	V780-HMD68-ETN-IN-S
			Indonesia	V780-HMD68-ETN-ID-S
			Malaysia	V780-HMD68-ETN-MY-S
			Singapore and Thailand	V780-HMD68-ETN-SG-S
			Under RE direct.	V780-HMD68-ETN-EU-S
			Russia	V780-HMD68-ETN-RU-S
			United States and Canada	V780-HMD68-ETN-US-S
			Mexico	V780-HMD68-ETN-MX-S

*1. Contact your Omron representative for details on products for other countries.

*2. Communicates via the master reader/writer (V780-HMD68-E□□-□□).

V780 Series

RF Tag

Appearance	Memory capacity	Size (mm)	Model
	1 KB	150 × 14 × 6	V780-A-JIME-Z3BLI-10 *

* Contains 10 RF Tags per package.

RF Tag Attachment

Appearance	Material	Size (mm)	Model
	Polycarbonate plastic	180 × 50 × 30	V780-A-TA-133-10 *

* Contains 10 RF Tag Attachments per package.

Note: 1. Use the RF Tag Attachment when mounting on metal surface. Refer to the User's Manual for how to mount.

2. Toppan Forms Co., Ltd. manufactures RF Tags and Attachments. For more information, visit the following website:
<http://www.toppan-f.co.jp/english/>

Cables

Recommended Ethernet Cables (Connection between Host Device and Reader/Writer)

Use STP (shielded twisted-pair) cable of category 5 or higher.

Specifications	Cable length (m) *	Model	
Wire Gauge and Number of Pairs: AWG22, 2-pair Cable	Cable with Plug on One End and Socket on Other End (M12 Straight/RJ45)	0.5	XS5W-T421-BME-K
		1	XS5W-T421-CME-K
		2	XS5W-T421-DME-K
		5	XS5W-T421-GME-K
		10	XS5W-T421-JME-K

* 3- and 15-m cables are also available.

Note: For details, refer to the *Industrial Ethernet Connectors Catalog* (Cat. No. G019).

Other cable lengths, robot cables, and extension cables are available. Contact your Omron representative for details.

Recommended Power Cables (Connection between Power Supply and Reader/Writer)



XS5F-D42□-□80-F

Specifications	Cable length (m)	Cable outer diameter (mm)	Straight Connectors	Angled Connectors
			Model	Model
Fire-retardant, Robot Cable	1	6	XS5F-D421-C80-F	XS5F-D422-C80-F
	2		XS5F-D421-D80-F	XS5F-D422-D80-F
	3		XS5F-D421-E80-F	XS5F-D422-E80-F
	5		XS5F-D421-G80-F	XS5F-D422-G80-F
	10		XS5F-D421-J80-F	XS5F-D422-J80-F

Note: For details, refer to the XS5 datasheet (<http://www.ia.omron.com/>).

Other cable lengths and extension cables are available. Contact your Omron representative for details.

Recommended Industrial Switching Hubs

Appearance	Specifications			Model
	Functions	No. of ports	Failure detection	
	Quality of Service (QoS): EtherNet/IP control data priority Failure detection:	3	No	W4S1-03B
	Broadcast storm and LSI error detection	5	No	W4S1-05B
	10/100BASE-TX, Auto-Negotiation	5	Yes	W4S1-05C

Ratings and Performance

Reader/Writer

General Specifications

Item	V780-HMD68-ETN-□□	V780-HMD68-EIP-□□	V780-HMD68-ETN-□□-S
Dimensions	250 × 250 × 70 mm (D × H × W, excluding protruding parts and cables)		
Supply voltage	24 VDC (-15% to +10%) Class2		
Power consumption	10 W max.		
Ambient operating temperature	-10 to 55°C (with no icing)		
Ambient operating humidity	25% to 85% (with no condensation)		
Ambient storage temperature	-25 to 70°C (with no icing)		
Ambient storage humidity	25% to 85% (with no condensation)		
Insulation resistance	20 MΩ min. (at 500 VDC) between cable terminals and case		
Dielectric strength	1,000 VAC, 50/60 Hz for 1 min between cable terminals and case		
Vibration resistance	No abnormality after application of 10 to 500 Hz, double amplitude: 1.5 mm, acceleration: 100 m/s ² , 10 sweeps in each of 3 axis directions (up/down, left/right, and forward/backward) for 11 minutes each		
Shock resistance	No abnormality after application of 500 m/s ² , 3 times each in 6 directions (Total: 18 times)		
Degree of protection	IP54 (IEC 60529:2001)		
Materials	Plastic case: PBT Metal case: Die-cast aluminum (ADC12)		
Weight	Approx. 3 kg		
Mounting method	Four M6 bolts		
Host communications interface	Ethernet 10BASE-T/100BASE-TX		
Host communications protocol	Modbus/TCP base	EtherNet/IP	Multi-Reader/Writer Function only *1
Multi-Reader/Writer function	Master/Slave	Master/Slave	Slave
Accessories	Instruction Sheet (1), IP address label (1), Startup Guide (1), Ferrite core (2) *2, and EU DECLARATION OF CONFORMITY (1) *3		
Regulations	See <i>Regulations</i> on page 13 for the regulations.		

*1. Communicates via the master reader/writer (V780-HMD68-E□□-□□) Although the PLC or other host device cannot control the slaves, the Web Server function (browser interface) can be used.

*2. A ferrite core is packaged with Model V780-HMD68-ETN-EU-IN.

*3. A EU DECLARATION OF CONFORMITY is packaged with Model V780-HMD68-ETN-EU.

Regulations

Model	Regulations
V780-HMD68-ETN-JP V780-HMD68-EIP-JP V780-HMD68-ETN-JP-S	Premises Radio Station (920-MHz-band Moving Object Differentiation Wireless Facilities), ARIB STD-T106
V780-HMD68-ETN-KR V780-HMD68-EIP-KR V780-HMD68-ETN-KR-S	무선설비규칙
V780-HMD68-ETN-CN V780-HMD68-EIP-CN V780-HMD68-ETN-CN-S	Ministry of Information Industry No. 205 (2007)
V780-HMD68-ETN-TW V780-HMD68-EIP-TW V780-HMD68-ETN-TW-S	NCC LP0002 4.8 RFID
V780-HMD68-ETN-IN V780-HMD68-EIP-IN V780-HMD68-ETN-IN-S	the G.S.R.36 (E)
V780-HMD68-ETN-ID V780-HMD68-EIP-ID V780-HMD68-ETN-ID-S	PERDIRJEN POSTEL Nomor: 221/DIRJEN/2007
V780-HMD68-ETN-MY V780-HMD68-EIP-MY V780-HMD68-ETN-MY-S	MCMC MTSFB TC T007:2014
V780-HMD68-ETN-SG V780-HMD68-ETN-SG-S	Singapore: IMDA TS SRD2 Thailand: NTC TS 1010-2550 (RFID 920-925 MHz)
V780-HMD68-ETN-EU V780-HMD68-EIP-EU V780-HMD68-ETN-EU-S	2014/53EU (RE Directive)
V780-HMD68-ETN-RU V780-HMD68-EIP-RU V780-HMD68-ETN-RU-S	к решению ГКПЧ от 07.05.2007 № 07-20-03-001
V780-HMD68-ETN-US V780-HMD68-EIP-US V780-HMD68-ETN-US-S	FCC 15.247 (United states) ISED RSS-247 (Canada)
V780-HMD68-ETN-MX V780-HMD68-EIP-MX V780-HMD68-ETN-MX-S	IFT-008 NYCE NOM-208

V780 Series

Tag Communications Specifications V780-HMD68-ETN-JP/V780-HMD68-EIP-JP/V780-HMD68-ETN-JP-S

Item	V780-HMD68-ETN-JP/V780-HMD68-EIP-JP/V780-HMD68-ETN-JP-S
Applicable countries	Japan
Maximum Radiated Power	4 W e.i.r.p
Output power	15 to 27 dBm (Switchable in 1-dB increments.)
RSSI detection range	Signal level: -35 to -61 dBm Noise level: -35 to -70 dBm (at end of antenna cable)
Transmission speed from Reader/Writer to RF Tag	40 kbps (fixed)
Transmission speed from RF Tag to Reader/Writer	<ul style="list-style-type: none"> • 80 kbps (High-speed Mode) * • 20 kbps (Standard Mode) *
Used frequencies (Described at the center frequency of each channel)	3 channels (916.8/918.0/919.2 MHz) License station
Channel interval	200 kHz
Communications method with RF Tags	Miller-modulated subcarrier
Tag communications protocol	ISO/IEC 18000-63: 2013 (EPCglobal Class-1 Generation-2)
Polarization characteristic	RHCP
Multiaccess communications	Up to 64 RF Tags can be read.

* The default setting is for Automatic Mode. The Reader/Writer will automatically change to High-speed Mode or Standard Mode depending on the interference waves.

V780-HMD68-ETN-KR/V780-HMD68-EIP-KR/V780-HMD68-ETN-KR-S

Item	V780-HMD68-ETN-KR/V780-HMD68-EIP-KR/V780-HMD68-ETN-KR-S
Applicable countries	Korea
Maximum Radiated Power	4 W e.i.r.p
Output power	15 to 27 dBm (Switchable in 1-dB increments.)
RSSI detection range	Signal level: -35 to -61 dBm Noise level: -35 to -70 dBm (at end of antenna cable)
Transmission speed from Reader/Writer to RF Tag	40 kbps (fixed)
Transmission speed from RF Tag to Reader/Writer	<ul style="list-style-type: none"> • 80 kbps (High-speed Mode) * • 31.25 kbps (Standard Mode) *
Used frequencies	6 channels (917.3/917.9/918.5/919.1/919.7/920.3 MHz) FHSS
Channel interval	200 kHz
Communications method with RF Tags	Miller-modulated subcarrier
Tag communications protocol	ISO/IEC 18000-63: 2013 (EPCglobal Class-1 Generation-2)
Polarization characteristic	RHCP
Multiaccess communications	Up to 64 RF Tags can be read.

* The default setting is for Automatic Mode. The Reader/Writer will automatically change to High-speed Mode or Standard Mode depending on the interference waves.

V780-HMD68-ETN-CN/V780-HMD68-EIP-CN/V780-HMD68-ETN-CN-S

Item	V780-HMD68-ETN-CN/V780-HMD68-EIP-CN/V780-HMD68-ETN-CN-S
Applicable countries	China
Maximum Radiated power	2 W e.r.p
Output power	15 to 27 dBm (Switchable in 1-dB increments.)
RSSI detection range	Signal level: -35 to -61 dBm Noise level: -35 to -70 dBm (at end of antenna cable)
Transmission speed from Reader/Writer to RF Tag	40 kbps (fixed)
Transmission speed from RF Tag to Reader/Writer	<ul style="list-style-type: none"> • 80 kbps (High-speed Mode) * • 20 kbps (Standard Mode) *
Used frequencies	16 channels (920.625 to 924.375 MHz) FHSS
Channel interval	250 kHz
Communications method with RF Tags	Miller-modulated subcarrier
Tag communications protocol	ISO/IEC 18000-63: 2013 (EPCglobal Class-1 Generation-2)
Polarization characteristic	RHCP
Multiaccess communications	Up to 64 RF Tags can be read.

* The default setting is for Automatic Mode. The Reader/Writer will automatically change to High-speed Mode or Standard Mode depending on the interference waves.

V780-HMD68-ETN-TW/V780-HMD68-EIP-TW/V780-HMD68-ETN-TW-S

Item	V780-HMD68-ETN-TW/V780-HMD68-EIP-TW/V780-HMD68-ETN-TW-S
Applicable countries	Taiwan
Maximum Radiated power	4 W e.i.r.p (indoor use only)
Output power	15 to 27 dBm (Switchable in 1-dB increments.)
RSSI detection range	Signal level: -35 to -61 dBm Noise level: -35 to -70 dBm (at end of antenna cable)
Transmission speed from Reader/Writer to RF Tag	40 kbps (fixed)
Transmission speed from RF Tag to Reader/Writer	<ul style="list-style-type: none"> • 80 kbps (High-speed Mode) * • 31.25 kbps (Standard Mode) *
Used frequencies	10 channels (922.75 to 927.25 MHz) FHSS
Channel interval	500 kHz
Communications method with RF Tags	Miller-modulated subcarrier
Tag communications protocol	ISO/IEC 18000-63: 2013 (EPCglobal Class-1 Generation-2)
Polarization characteristic	RHCP
Multiaccess communications	Up to 64 RF Tags can be read.

* The default setting is for Automatic Mode. The Reader/Writer will automatically change to High-speed Mode or Standard Mode depending on the interference waves.

V780-HMD68-ETN-IN/V780-HMD68-EIP-IN/V780-HMD68-ETN-IN-S

Item	V780-HMD68-ETN-IN/V780-HMD68-EIP-IN/V780-HMD68-ETN-IN-S
Applicable countries	India
Maximum Radiated Power	2 W e.r.p
Output power	15 to 27 dBm (Switchable in 1-dB increments.)
RSSI detection range	Signal level: -35 to -61 dBm Noise level: -35 to -70 dBm (at end of antenna cable)
Transmission speed from Reader/Writer to RF Tag	40 kbps (fixed)
Transmission speed from RF Tag to Reader/Writer	<ul style="list-style-type: none"> • 80 kbps (High-speed Mode) * • 31.25 kbps (Standard Mode) *
Used frequencies	3 channels (865.7/866.3/866.9 MHz) FHSS
Channel interval	200 kHz
Communications method with RF Tags	Miller-modulated subcarrier
Tag communications protocol	ISO/IEC 18000-63: 2013 (EPCglobal Class-1 Generation-2)
Polarization characteristic	RHCP
Multiaccess communications	Up to 64 RF Tags can be read.

* The default setting is for Automatic Mode. The Reader/Writer will automatically change to High-speed Mode or Standard Mode depending on the interference waves.

V780-HMD68-ETN-ID/V780-HMD68-EIP-ID/V780-HMD68-ETN-ID-S

Item	V780-HMD68-ETN-ID/V780-HMD68-EIP-ID/V780-HMD68-ETN-ID-S
Applicable countries	Indonesia
Maximum Radiated power	2 W e.r.p
Output power	15 to 27 dBm (Switchable in 1-dB increments.)
RSSI detection range	Signal level: -35 to -61 dBm Noise level: -35 to -70 dBm (at end of antenna cable)
Transmission speed from Reader/Writer to RF Tag	40 kbps (fixed)
Transmission speed from RF Tag to Reader/Writer	<ul style="list-style-type: none"> • 80 kbps (High-speed Mode) * • 31.25 kbps (Standard Mode) *
Used frequencies	4 channels (923.25/923.75/924.25/924.75 MHz) FHSS
Channel interval	500 kHz
Communications method with RF Tags	Miller-modulated subcarrier
Tag communications protocol	ISO/IEC 18000-63: 2013 (EPCglobal Class-1 Generation-2)
Polarization characteristic	RHCP
Multiaccess communications	Up to 64 RF Tags can be read.

* The default setting is for Automatic Mode. The Reader/Writer will automatically change to High-speed Mode or Standard Mode depending on the interference waves.

V780 Series

V780-HMD68-ETN-MY/V780-HMD68-EIP-MY/V780-HMD68-ETN-MY-S

Item	V780-HMD68-ETN-MY/V780-HMD68-EIP-MY/V780-HMD68-ETN-MY-S
Applicable countries	Malaysia
Maximum Radiated power	2 W e.r.p
Output power	15 to 27 dBm (Switchable in 1-dB increments.)
RSSI detection range	Signal level: -35 to -61 dBm Noise level: -35 to -70 dBm (at end of antenna cable)
Transmission speed from Reader/Writer to RF Tag	40 kbps (fixed)
Transmission speed from RF Tag to Reader/Writer	<ul style="list-style-type: none"> • 80 kbps (High-speed Mode) * • 31.25 kbps (Standard Mode) *
Used frequencies	8 channels (919.25 to 922.75 MHz) FHSS
Channel interval	500 kHz
Communications method with RF Tags	Miller-modulated subcarrier
Tag communications protocol	ISO/IEC 18000-63: 2013 (EPCglobal Class-1 Generation-2)
Polarization characteristic	RHCP
Multiaccess communications	Up to 64 RF Tags can be read.

* The default setting is for Automatic Mode. The Reader/Writer will automatically change to High-speed Mode or Standard Mode depending on the interference waves.

V780-HMD68-ETN-SG/V780-HMD68-ETN-SG-S

Item	V780-HMD68-ETN-SG/V780-HMD68-ETN-SG-S
Applicable countries	Singapore and Thailand
Maximum Radiated Power	2 W e.r.p
Output power	15 to 27 dBm (Switchable in 1-dB increments.)
RSSI detection range	Signal level: -35 to -61 dBm Noise level: -35 to -70 dBm (at end of antenna cable)
Transmission speed from Reader/Writer to RF Tag	40 kbps (fixed)
Transmission speed from RF Tag to Reader/Writer	<ul style="list-style-type: none"> • 80 kbps (High-speed Mode) * • 31.25 kbps (Standard Mode) *
Used frequencies	8 channels (920.75 to 924.25 MHz) FHSS
Channel interval	500 kHz
Communications method with RF Tags	Miller-modulated subcarrier
Tag communications protocol	ISO/IEC 18000-63: 2013 (EPCglobal Class-1 Generation-2)
Polarization characteristic	RHCP
Multiaccess communications	Up to 64 RF Tags can be read.

* The default setting is for Automatic Mode. The Reader/Writer will automatically change to High-speed Mode or Standard Mode depending on the interference waves.

V780-HMD68-ETN-EU/V780-HMD68-EIP-EU/V780-HMD68-ETN-EU-S

Item	V780-HMD68-ETN-EU/V780-HMD68-EIP-EU/V780-HMD68-ETN-EU-S
Applicable countries	Under RE direct
Maximum Radiated Power	2 W e.r.p
Output power	15 to 27 dBm (Switchable in 1-dB increments.)
RSSI detection range	Signal level: -35 to -61 dBm Noise level: -35 to -70 dBm (at end of antenna cable)
Transmission speed from Reader/Writer to RF Tag	40 kbps (fixed)
Transmission speed from RF Tag to Reader/Writer	<ul style="list-style-type: none"> • 80 kbps (High-speed Mode) * • 31.25 kbps (Standard Mode) *
Used frequencies	4 channels (865.7/866.3/866.9/867.5 MHz) FHSS
Channel interval	200 kHz
Communications method with RF Tags	Miller-modulated subcarrier
Tag communications protocol	ISO/IEC 18000-63: 2013 (EPCglobal Class-1 Generation-2)
Polarization characteristic	RHCP
Multiaccess communications	Up to 64 RF Tags can be read.

* The default setting is for Automatic Mode. The Reader/Writer will automatically change to High-speed Mode or Standard Mode depending on the interference waves.

V780-HMD68-ETN-RU/V780-HMD68-EIP-RU/V780-HMD68-ETN-RU-S

Item	V780-HMD68-ETN-RU/V780-HMD68-EIP-RU/V780-HMD68-ETN-RU-S
Applicable countries	Russia
Maximum Radiated Power	2 W e.r.p
Output power	15 to 27 dBm (Switchable in 1-dB increments.)
RSSI detection range	Signal level: -35 to -61 dBm Noise level: -35 to -70 dBm (at end of antenna cable)
Transmission speed from Reader/Writer to RF Tag	40 kbps (fixed)
Transmission speed from RF Tag to Reader/Writer	<ul style="list-style-type: none"> • 80 kbps (High-speed Mode) * • 31.25 kbps (Standard Mode) *
Used frequencies	3 channels (866.3/866.9/867.5 MHz) FHSS
Channel interval	200 kHz
Communications method with RF Tags	Miller-modulated subcarrier
Tag communications protocol	ISO/IEC 18000-63: 2013 (EPCglobal Class-1 Generation-2)
Polarization characteristic	RHCP
Multiaccess communications	Up to 64 RF Tags can be read.

* The default setting is for Automatic Mode. The Reader/Writer will automatically change to High-speed Mode or Standard Mode depending on the interference waves.

V780-HMD68-ETN-US/V780-HMD68-EIP-US/V780-HMD68-ETN-US-S

Item	V780-HMD68-ETN-US/V780-HMD68-EIP-US/V780-HMD68-ETN-US-S
Applicable countries	United States and Canada
Maximum Radiated Power	4 W e.i.r.p
Output power	15 to 27 dBm (Switchable in 1-dB increments.)
RSSI detection range	Signal level: -35 to -61 dBm Noise level: -35 to -70 dBm (at end of antenna cable)
Transmission speed from Reader/Writer to RF Tag	40 kbps (fixed)
Transmission speed from RF Tag to Reader/Writer	<ul style="list-style-type: none"> • 80 kbps (High-speed Mode) * • 31.25 kbps (Standard Mode) *
Used frequencies	50 channels (902.75 to 927.25 MHz) FHSS
Channel interval	500 kHz
Communications method with RF Tags	Miller-modulated subcarrier
Tag communications protocol	ISO/IEC 18000-63: 2013 (EPCglobal Class-1 Generation-2)
Polarization characteristic	RHCP
Multiaccess communications	Up to 64 RF Tags can be read.

* The default setting is for Automatic Mode. The Reader/Writer will automatically change to High-speed Mode or Standard Mode depending on the interference waves.

V780-HMD68-ETN-MX/V780-HMD68-EIP-MX/V780-HMD68-ETN-MX-S

Item	V780-HMD68-ETN-MX/V780-HMD68-EIP-MX/V780-HMD68-ETN-MX-S
Applicable countries	Mexico
Maximum Radiated Power	4 W e.i.r.p
Output power	15 to 27 dBm (Switchable in 1-dB increments.)
RSSI detection range	Signal level: -35 to -61 dBm Noise level: -35 to -70 dBm (at end of antenna cable)
Transmission speed from Reader/Writer to RF Tag	40 kbps (fixed)
Transmission speed from RF Tag to Reader/Writer	<ul style="list-style-type: none"> • 80 kbps (High-speed Mode) * • 31.25 kbps (Standard Mode) *
Used frequencies	50 channels (902.75 to 927.25 MHz) FHSS
Channel interval	500 kHz
Communications method with RF Tags	Miller-modulated subcarrier
Tag communications protocol	ISO/IEC 18000-63: 2013 (EPCglobal Class-1 Generation-2)
Polarization characteristic	RHCP
Multiaccess communications	Up to 64 RF Tags can be read.

* The default setting is for Automatic Mode. The Reader/Writer will automatically change to High-speed Mode or Standard Mode depending on the interference waves.

V780 Series

Recommended Power Supply (24 VDC)

Item	Condition
Supply voltage	24 VDC -15% to +10%
Output current	500 mA min.
Safety standard	SELV (Safety Extra Low Voltage)

RF Tag (Recommended)

Item	Model	V780-A-JIME-Z3BLI-10 (made by Toppan Forms Co., Ltd.)
Dimensions		150 × 14 × 6 mm (W × H × D)
IC chip, memory		Monza X 8K UII(EPC): 128 bits User memory: 8,192 bits
Write life / Data retention		10,000 writes / 10 years
		100,000 writes / 1 year
Operating temperature		-20 to 65°C
Operating humidity		5% to 95%
Storage temperature		-30 to 70°C
Storage humidity		5% to 95%
Material		Polycarbonate plastic
Weight		Tag: Approx. 15 g
Degree of protection		IP68 (IEC 60529: 2001)

RF Tag Attachment (Recommended)

Item	Model	V780-A-TA-133 (made by Toppan Forms Co., Ltd.)
Dimensions		180 × 50 × 30 mm (W × H × D)
Operating temperature		-20 to 65°C
Operating humidity		5% to 95%
Storage temperature		-30 to 70°C
Storage humidity		5% to 95%
Material		Polycarbonate plastic
Weight		Approx. 128 g

Characteristic Data V780-HMD68-ETN-JP/V780-HMD68-EIP-JP/V780-HMD68-ETN-JP-S (for Reference Only)

Communications range

The communications range differs depending on the radio regulations of each country. Moreover, the communications range may change under the influence of the ambient environment, type of RF Tags, and the items on which RF Tags are mounted. Sufficiently verify the communications range in advance.

RF Tag : V780-A-JIME-Z3BLI-10 (Toppan Forms Co., Ltd.)
(Back Surface: Metal, with Attachment, V780-A-TA-133-10)

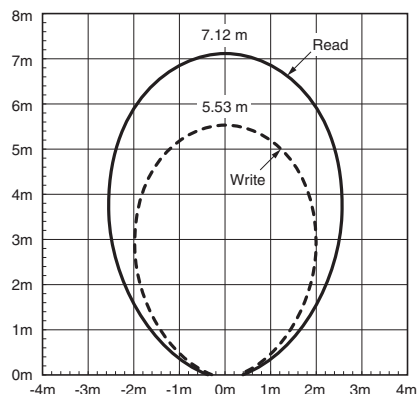

RF Tag Communications Times

The communications time differs depending on the radio regulations of each country, or the settings of the RF communications command and RF communications speed. In actual usage, the communications time may change under the influence of the installation environment, system conditions, type of RF Tags, and other factors. Perform sufficient testing in advance.

RF Tag : V780-A-JIME-Z3BLI-10 (Toppan Forms Co., Ltd.)

ID READ (Single-access)

During 6-word (96bit) data readout from the UII (EPC) area

RF communications speed	Communications time
High speed	15 ms
Normal speed	27 ms

DATA READ (Single-access)

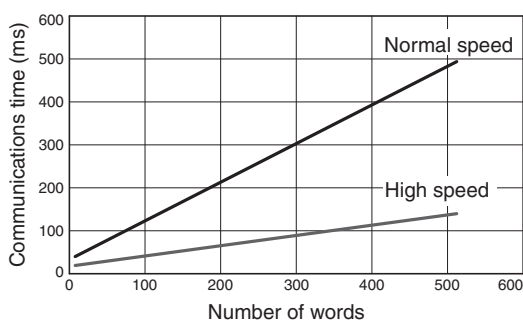

DATA WRITE (Single-access)

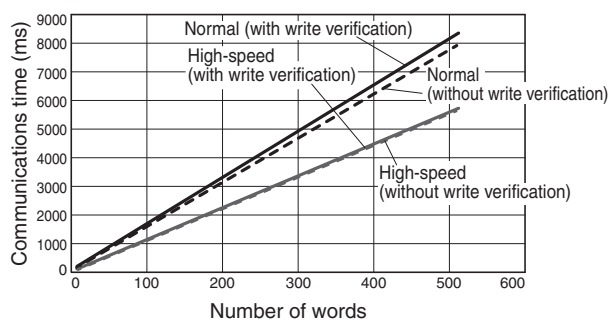

ID READ (Multi-access)

During 6-word (96bit) data readout from the UII (EPC) area

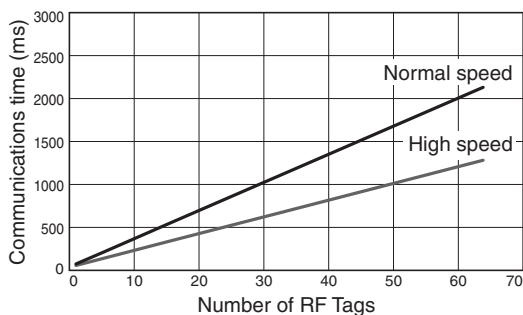

DATA READ (Multi-access)

Reading 32 Words of Data from the User Area

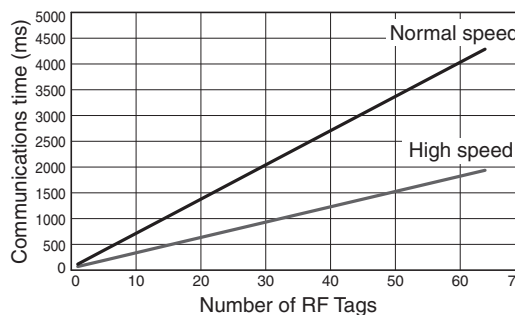

V780 Series

Characteristic Data V780-HMD68-ETN-KR/V780-HMD68-EIP-KR/V780-HMD68-ETN-KR-S (for Reference Only)

Communications range

The communications range differs depending on the radio regulations of each country. Moreover, the communications range may change under the influence of the ambient environment, type of RF Tags, and the items on which RF Tags are mounted. Sufficiently verify the communications range in advance.

RF Tag : V780-A-JIME-Z3BLI-10 (Toppan Forms Co., Ltd.)
(Back Surface: Metal, with Attachment, V780-A-TA-133-10)

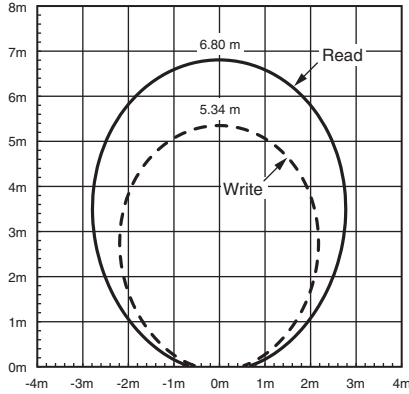

RF Tag Communication Times

The communications time differs depending on the radio regulations of each country, or the settings of the RF communications command and RF communications speed. In actual usage, the communications time may change under the influence of the installation environment, system conditions, type of RF Tags, and other factors. Perform sufficient testing in advance.

RF Tag : V780-A-JIME-Z3BLI-10 (Toppan Forms Co., Ltd.)
ID READ (Single-access)

During 6-word (96bit) data readout from the Ull (EPC) area

RF communications speed	Communications time
High speed	21 ms
Normal speed	27 ms

DATA READ (Single-access)

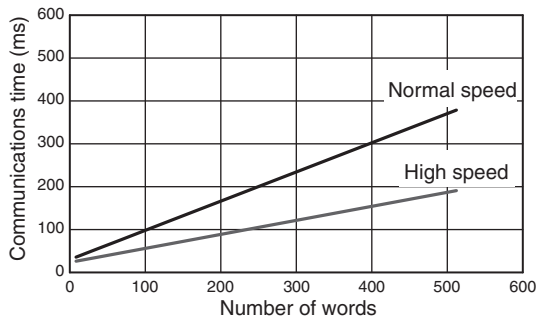

DATA WRITE (Single-access)

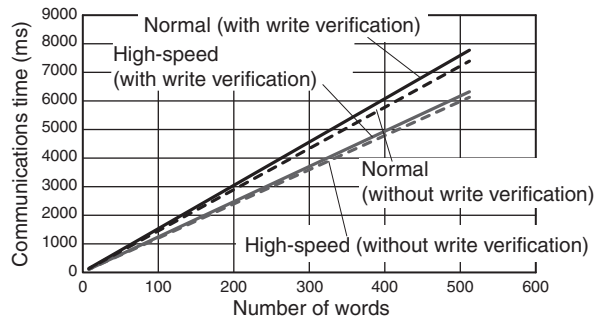

ID READ (Multi-access)

During 6-word (96bit) data readout from the Ull (EPC) area

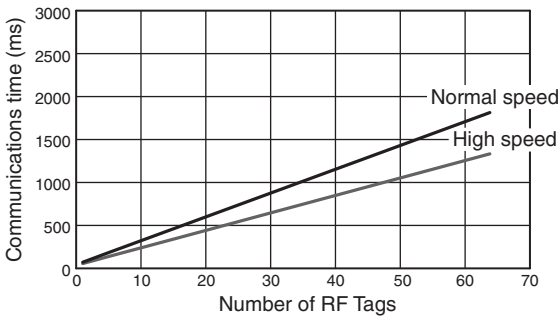

DATA READ (Multi-access)

Reading 32 Words of Data from the User Area

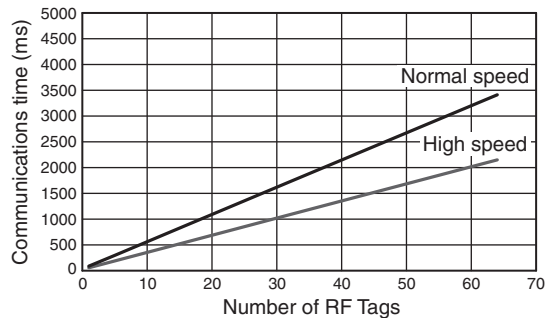

Characteristic Data V780-HMD68-ETN-CN/V780-HMD68-EIP-CN/V780-HMD68-ETN-CN-S (for Reference Only)

Communications range

The communications range differs depending on the radio regulations of each country. Moreover, the communications range may change under the influence of the ambient environment, type of RF Tags, and the items on which RF Tags are mounted. Sufficiently verify the communications range in advance.

RF Tag : V780-A-JIME-Z3BLI-10 (Toppan Forms Co., Ltd.)
(Back Surface: Metal, with Attachment, V780-A-TA-133-10)

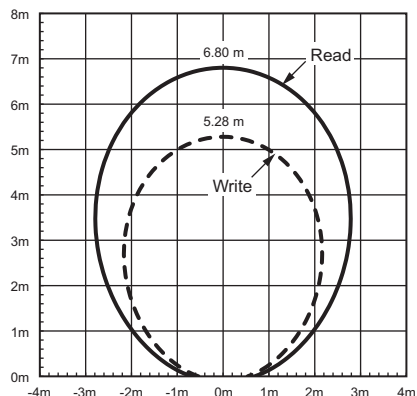

RF Tag Communication Times

The communications time differs depending on the radio regulations of each country, or the settings of the RF communications command and RF communications speed. In actual usage, the communications time may change under the influence of the installation environment, system conditions, type of RF Tags, and other factors. Perform sufficient testing in advance.

RF Tag : V780-A-JIME-Z3BLI-10 (Toppan Forms Co., Ltd.)

ID READ (Single-access)

During 6-word (96bit) data readout from the UII (EPC) area

RF communications speed	Communications time
High speed	17 ms
Normal speed	29 ms

DATA READ (Single-access)

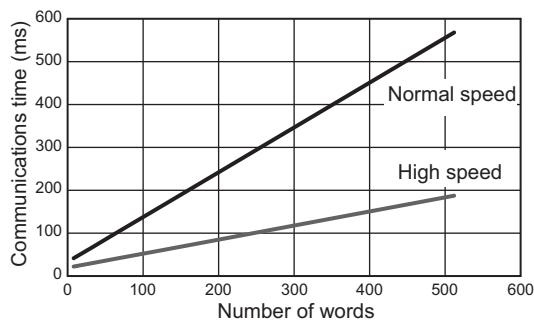

DATA WRITE (Single-access)

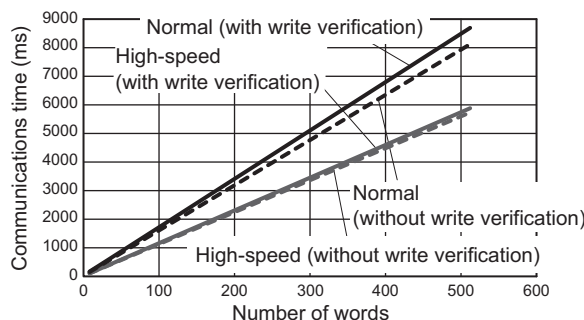

ID READ (Multi-access)

During 6-word (96bit) data readout from the UII (EPC) area

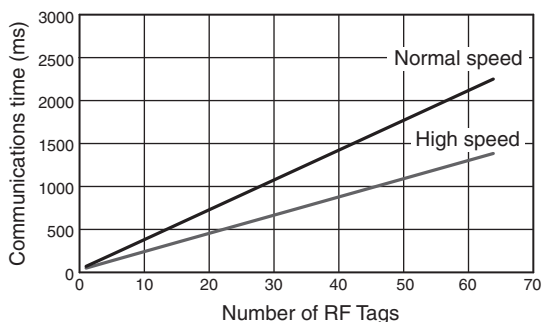

DATA READ (Multi-access)

Reading 32 Words of Data from the User Area

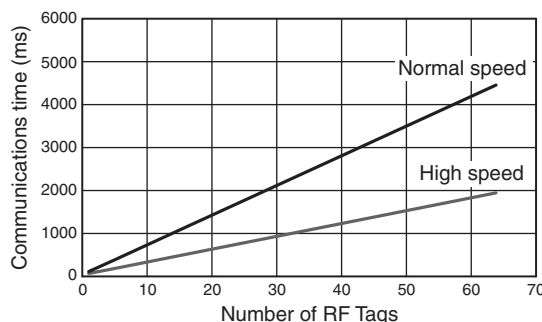

V780 Series

Characteristic Data V780-HMD68-ETN-TW/V780-HMD68-EIP-TW/V780-HMD68-ETN-TW-S (for Reference Only)

Communications range

The communications range differs depending on the radio regulations of each country. Moreover, the communications range may change under the influence of the ambient environment, type of RF Tags, and the items on which RF Tags are mounted. Sufficiently verify the communications range in advance.

RF Tag : V780-A-JIME-Z3BLI-10 (Toppan Forms Co., Ltd.)
(Back Surface: Metal, with Attachment, V780-A-TA-133-10)

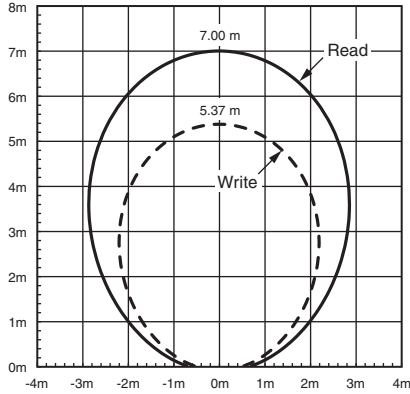

RF Tag Communication Times

The communications time differs depending on the radio regulations of each country, or the settings of the RF communications command and RF communications speed. In actual usage, the communications time may change under the influence of the installation environment, system conditions, type of RF Tags, and other factors. Perform sufficient testing in advance.

RF Tag : V780-A-JIME-Z3BLI-10 (Toppan Forms Co., Ltd.)
ID READ (Single-access)

During 6-word (96bit) data readout from the Ull (EPC) area

RF communications speed	Communications time
High speed	21 ms
Normal speed	27 ms

DATA READ (Single-access)

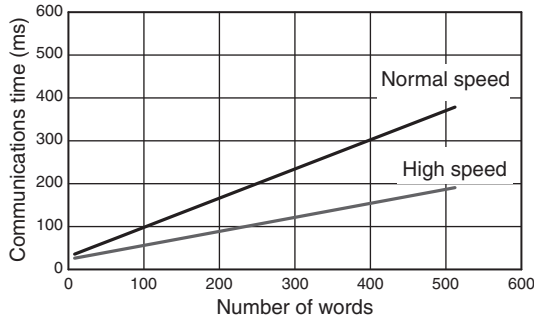

DATA WRITE (Single-access)

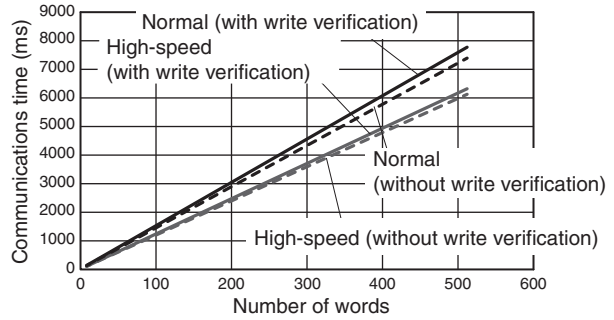

ID READ (Multi-access)

During 6-word (96bit) data readout from the Ull (EPC) area

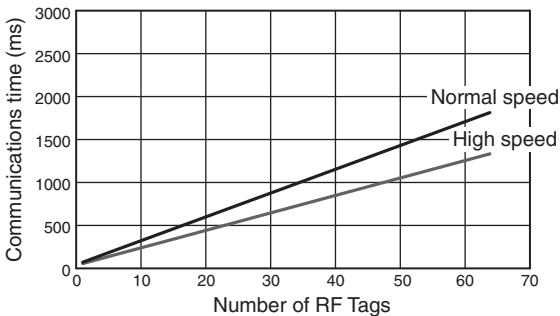

DATA READ (Multi-access)

Reading 32 Words of Data from the User Area

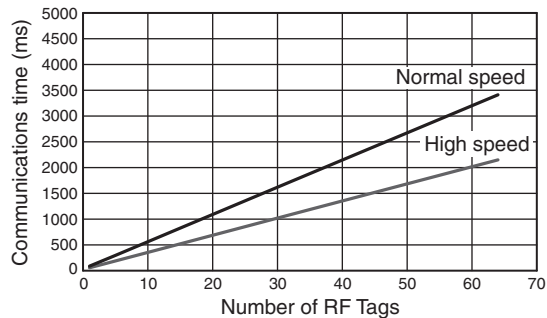

Characteristic Data V780-HMD68-ETN-IN/V780-HMD68-EIP-IN/V780-HMD68-ETN-IN-S (for Reference Only)

Communications range

The communications range differs depending on the radio regulations of each country. Moreover, the communications range may change under the influence of the ambient environment, type of RF Tags, and the items on which RF Tags are mounted. Sufficiently verify the communications range in advance.

RF Tag : V780-A-JIME-Z3BLI-10 (Toppan Forms Co., Ltd.)
(Back Surface: Metal, with Attachment, V780-A-TA-133-10)

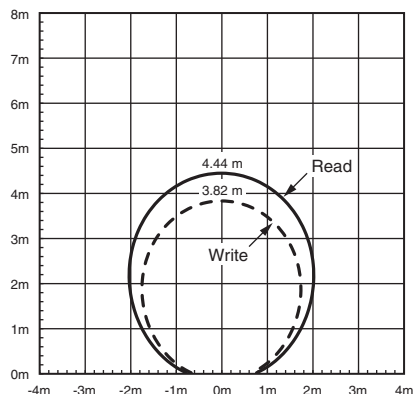

RF Tag Communication Times

The communications time differs depending on the radio regulations of each country, or the settings of the RF communications command and RF communications speed. In actual usage, the communications time may change under the influence of the installation environment, system conditions, type of RF Tags, and other factors. Perform sufficient testing in advance.

RF Tag : V780-A-JIME-Z3BLI-10 (Toppan Forms Co., Ltd.)

ID READ (Single-access)

During 6-word (96bit) data readout from the UII (EPC) area

RF communications speed	Communications time
High speed	21 ms
Normal speed	27 ms

DATA READ (Single-access)

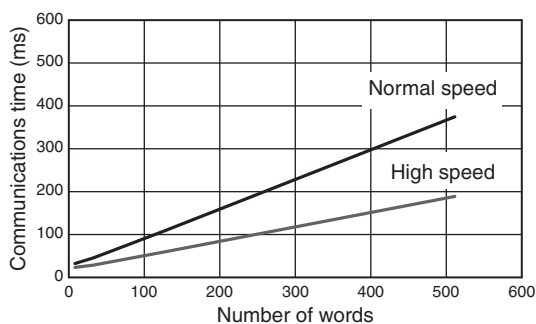

DATA WRITE (Single-access)

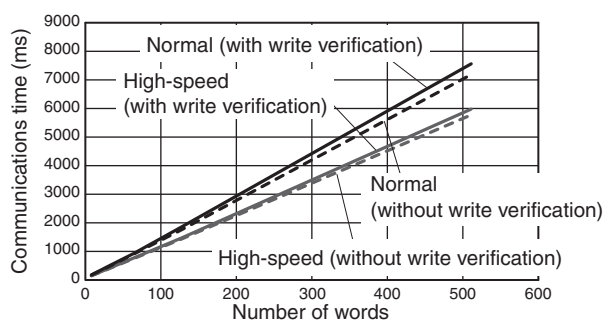

ID READ (Multi-access)

During 6-word (96bit) data readout from the UII (EPC) area

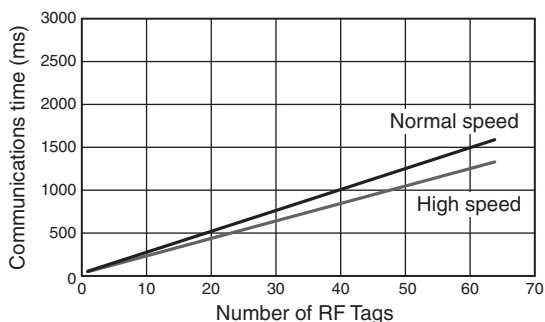

DATA READ (Multi-access)

Reading 32 Words of Data from the User Area

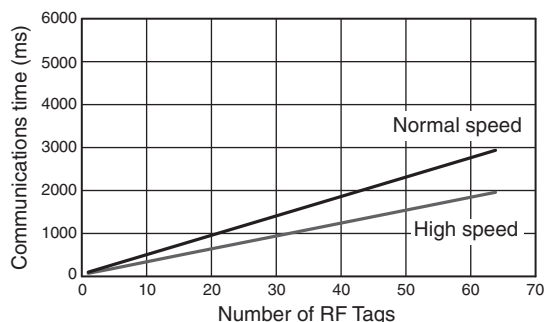

V780 Series

Characteristic Data V780-HMD68-ETN-ID/V780-HMD68-EIP-ID/V780-HMD68-ETN-ID-S (for Reference Only)

Communications range

The communications range differs depending on the radio regulations of each country. Moreover, the communications range may change under the influence of the ambient environment, type of RF Tags, and the items on which RF Tags are mounted. Sufficiently verify the communications range in advance.

RF Tag : V780-A-JIME-Z3BLI-10 (Toppan Forms Co., Ltd.)
(Back Surface: Metal, with Attachment, V780-A-TA-133-10)

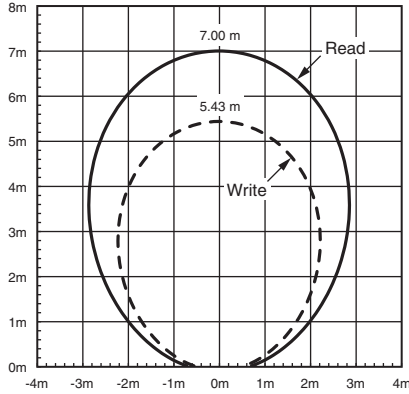

RF Tag Communication Times

The communications time differs depending on the radio regulations of each country, or the settings of the RF communications command and RF communications speed. In actual usage, the communications time may change under the influence of the installation environment, system conditions, type of RF Tags, and other factors. Perform sufficient testing in advance.

RF Tag : V780-A-JIME-Z3BLI-10 (Toppan Forms Co., Ltd.)
ID READ (Single-access)

During 6-word (96bit) data readout from the UII (EPC) area

RF communications speed	Communications time
High speed	21 ms
Normal speed	27 ms

DATA READ (Single-access)

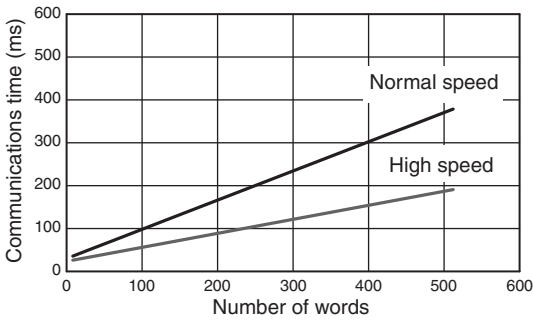

DATA WRITE (Single-access)

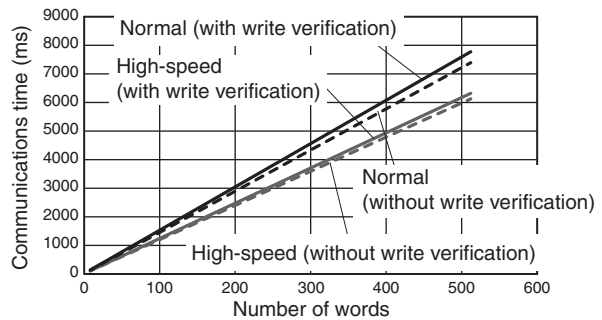

ID READ (Multi-access)

During 6-word (96bit) data readout from the UII (EPC) area

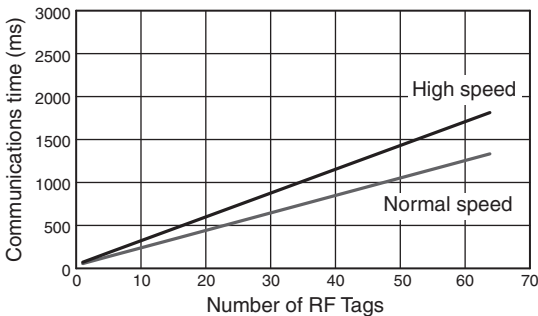

DATA READ (Multi-access)

Reading 32 Words of Data from the User Area

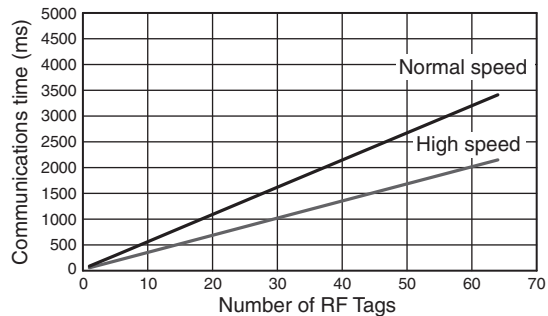

Characteristic Data V780-HMD68-ETN-MY/V780-HMD68-EIP-MY/V780-HMD68-ETN-MY-S (for Reference Only)

Communications range

The communications range differs depending on the radio regulations of each country. Moreover, the communications range may change under the influence of the ambient environment, type of RF Tags, and the items on which RF Tags are mounted. Sufficiently verify the communications range in advance.

RF Tag : V780-A-JIME-Z3BLI-10 (Toppan Forms Co., Ltd.)
(Back Surface: Metal, with Attachment, V780-A-TA-133-10)

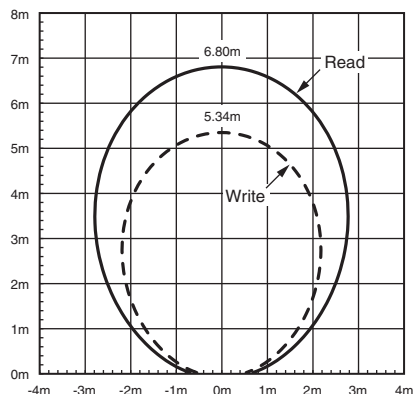

RF Tag Communication Times

The communications time differs depending on the radio regulations of each country, or the settings of the RF communications command and RF communications speed. In actual usage, the communications time may change under the influence of the installation environment, system conditions, type of RF Tags, and other factors. Perform sufficient testing in advance.

RF Tag : V780-A-JIME-Z3BLI-10 (Toppan Forms Co., Ltd.)
ID READ (Single-access)

During 6-word (96bit) data readout from the UII (EPC) area

RF communications speed	Communications time
High speed	21 ms
Normal speed	27 ms

DATA READ (Single-access)

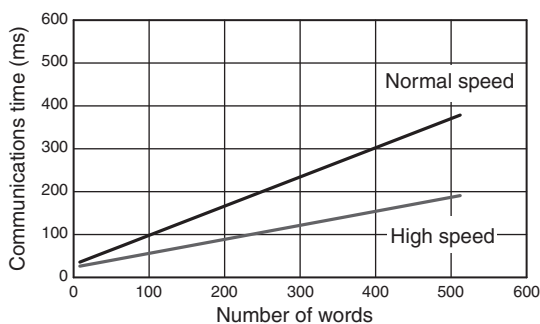

DATA WRITE (Single-access)

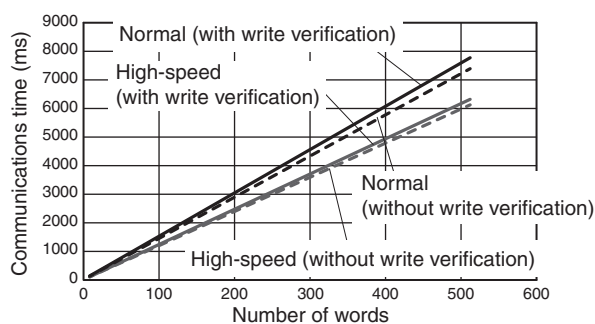

ID READ (Multi-access)

During 6-word (96bit) data readout from the UII (EPC) area

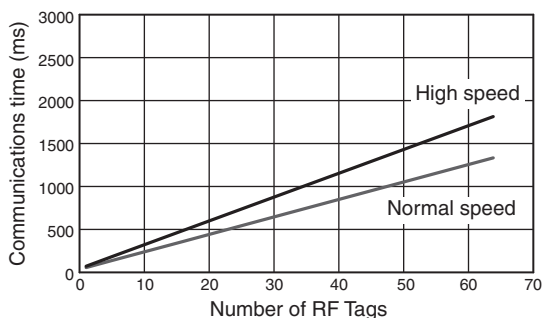

DATA READ (Multi-access)

Reading 32 Words of Data from the User Area

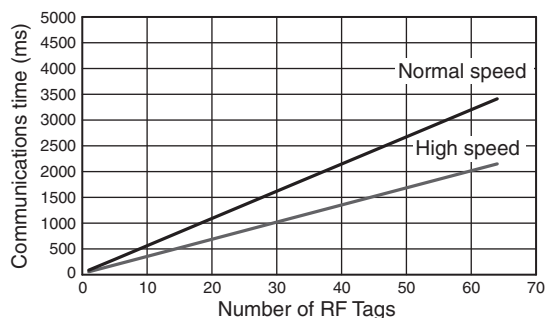

V780 Series

Characteristic Data V780-HMD68-ETN-SG/V780-HMD68-ETN-SG-S (for Reference Only)

Communications range

The communications range differs depending on the radio regulations of each country. Moreover, the communications range may change under the influence of the ambient environment, type of RF Tags, and the items on which RF Tags are mounted. Sufficiently verify the communications range in advance.

RF Tag : V780-A-JIME-Z3BLI-10 (Toppan Forms Co., Ltd.)
(Back Surface: Metal, with Attachment, V780-A-TA-133-10)

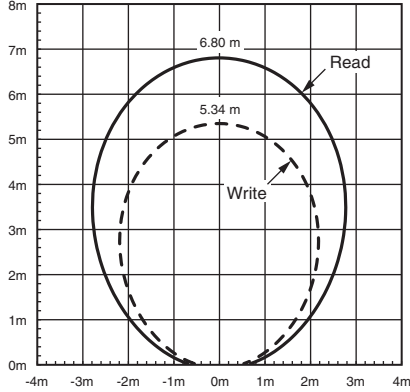

RF Tag Communication Times

The communications time differs depending on the radio regulations of each country, or the settings of the RF communications command and RF communications speed. In actual usage, the communications time may change under the influence of the installation environment, system conditions, type of RF Tags, and other factors. Perform sufficient testing in advance.

RF Tag : V780-A-JIME-Z3BLI-10 (Toppan Forms Co., Ltd.)
ID READ (Single-access)

During 6-word (96bit) data readout from the Ull (EPC) area

RF communications speed	Communications time
High speed	21 ms
Normal speed	27 ms

DATA READ (Single-access)

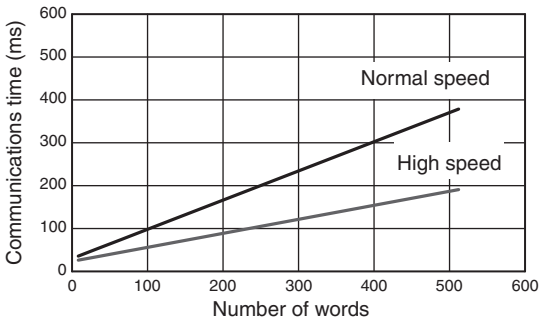

DATA WRITE (Single-access)

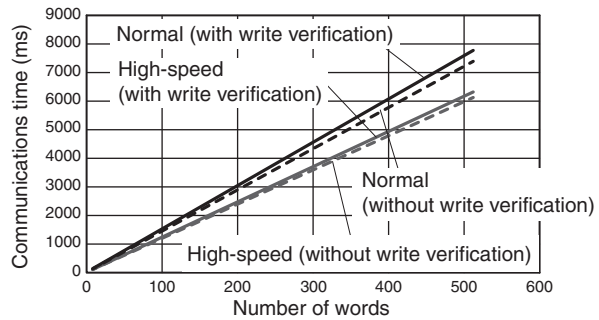

ID READ (Multi-access)

During 6-word (96bit) data readout from the Ull (EPC) area

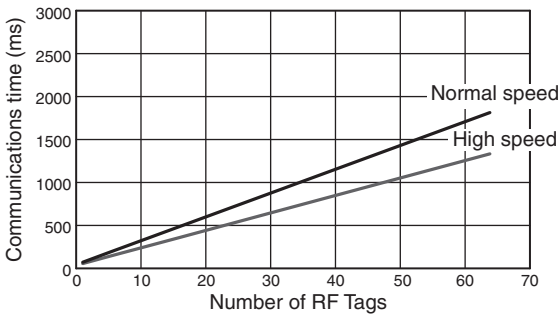

DATA READ (Multi-access)

Reading 32 Words of Data from the User Area

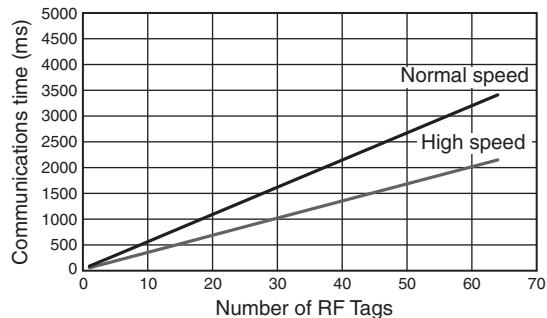

Characteristic Data V780-HMD68-ETN-EU/V780-HMD68-EIP-EU/V780-HMD68-ETN-EU-S (for Reference Only)

Communications range

The communications range differs depending on the radio regulations of each country. Moreover, the communications range may change under the influence of the ambient environment, type of RF Tags, and the items on which RF Tags are mounted. Sufficiently verify the communications range in advance.

RF Tag : V780-A-JIME-Z3BLI-10 (Toppan Forms Co., Ltd.)
(Back Surface: Metal, with Attachment, V780-A-TA-133-10)

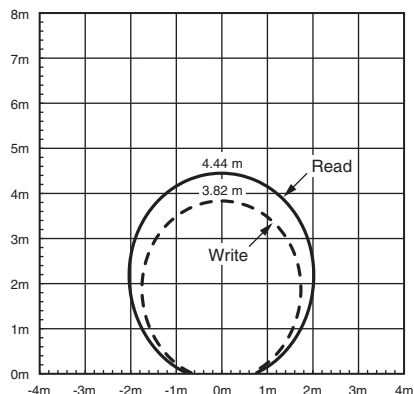

RF Tag Communication Times

The communications time differs depending on the radio regulations of each country, or the settings of the RF communications command and RF communications speed. In actual usage, the communications time may change under the influence of the installation environment, system conditions, type of RF Tags, and other factors. Perform sufficient testing in advance.

RF Tag : V780-A-JIME-Z3BLI-10 (Toppan Forms Co., Ltd.)

ID READ (Single-access)

During 6-word (96bit) data readout from the UII (EPC) area

RF communications speed	Communications time
High speed	21 ms
Normal speed	27 ms

DATA READ (Single-access)

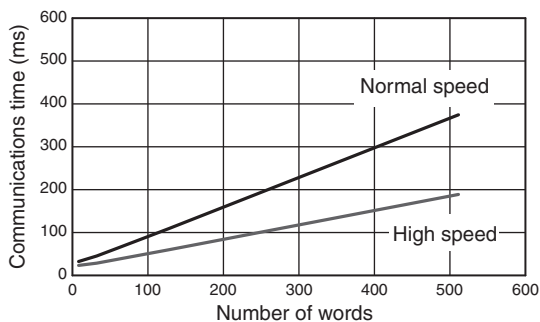

DATA WRITE (Single-access)

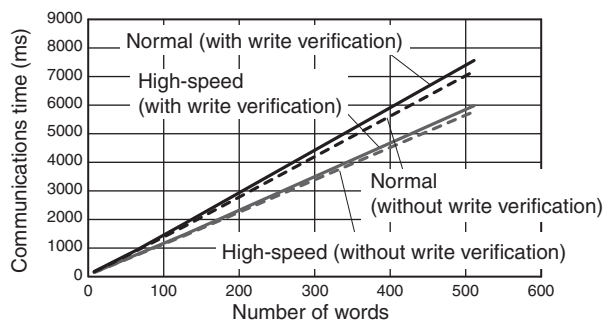

ID READ (Multi-access)

During 6-word (96bit) data readout from the UII (EPC) area

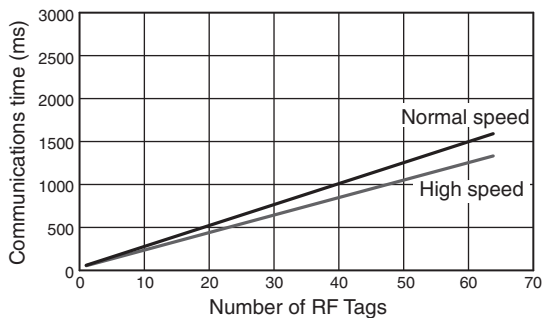

DATA READ (Multi-access)

Reading 32 Words of Data from the User Area

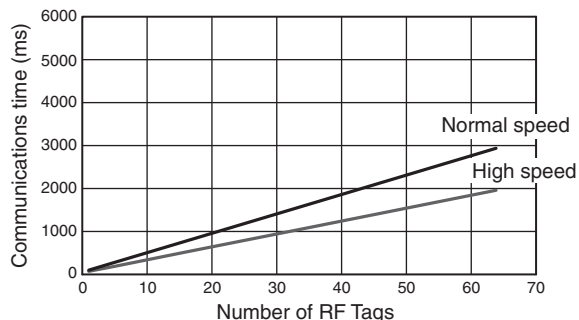

V780 Series

Characteristic Data V780-HMD68-ETN-RU/V780-HMD68-EIP-RU/V780-HMD68-ETN-RU-S (for Reference Only)

Communications range

The communications range differs depending on the radio regulations of each country. Moreover, the communications range may change under the influence of the ambient environment, type of RF Tags, and the items on which RF Tags are mounted. Sufficiently verify the communications range in advance.

RF Tag : V780-A-JIME-Z3BLI-10 (Toppan Forms Co., Ltd.)
(Back Surface: Metal, with Attachment, V780-A-TA-133-10)

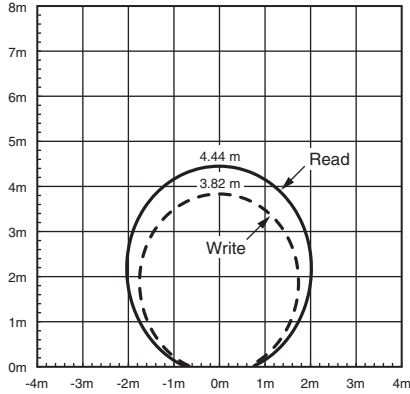

RF Tag Communication Times

The communications time differs depending on the radio regulations of each country, or the settings of the RF communications command and RF communications speed. In actual usage, the communications time may change under the influence of the installation environment, system conditions, type of RF Tags, and other factors. Perform sufficient testing in advance.

RF Tag : V780-A-JIME-Z3BLI-10 (Toppan Forms Co., Ltd.)
ID READ (Single-access)

During 6-word (96bit) data readout from the UII (EPC) area

RF communications speed	Communications time
High speed	21 ms
Normal speed	27 ms

DATA READ (Single-access)

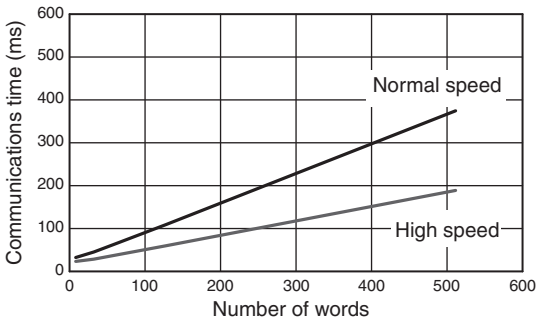

DATA WRITE (Single-access)

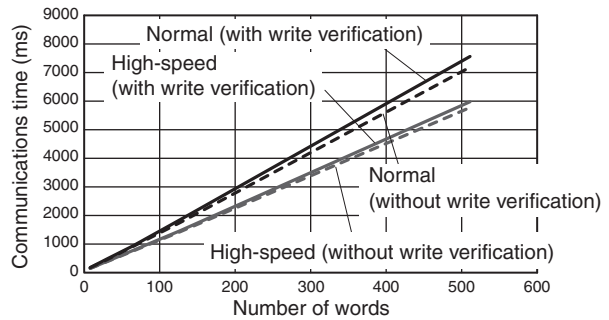

ID READ (Multi-access)

During 6-word (96bit) data readout from the UII (EPC) area

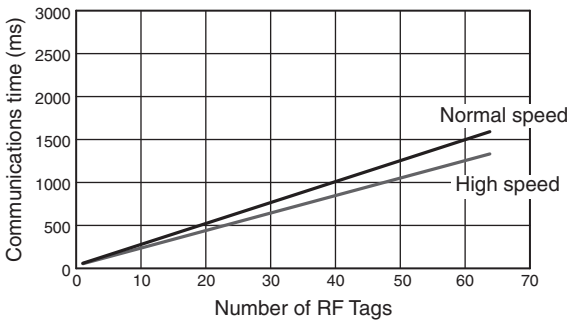

DATA READ (Multi-access)

Reading 32 Words of Data from the User Area

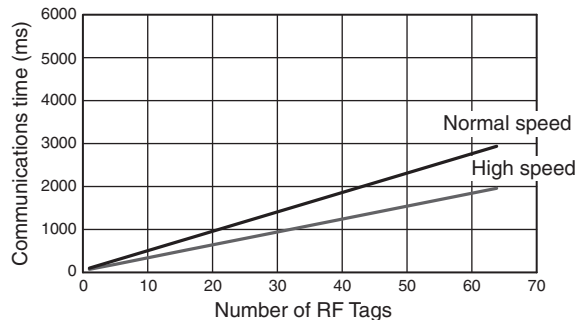

Characteristic Data V780-HMD68-ETN-US/V780-HMD68-EIP-US/V780-HMD68-ETN-US-S (for Reference Only)

Communications range

The communications range differs depending on the radio regulations of each country. Moreover, the communications range may change under the influence of the ambient environment, type of RF Tags, and the items on which RF Tags are mounted. Sufficiently verify the communications range in advance.

RF Tag : V780-A-JIME-Z3BLI-10 (Toppan Forms Co., Ltd.)
(Back Surface: Metal, with Attachment, V780-A-TA-133-10)

Transmission power: 27dBm

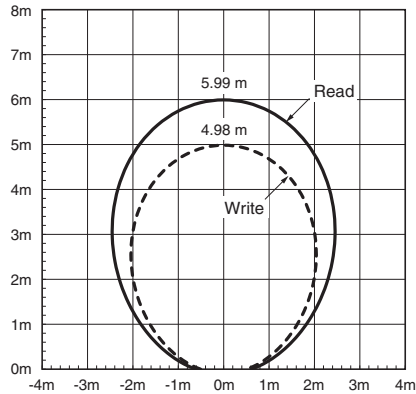

RF Tag Communication Times

The communications time differs depending on the radio regulations of each country, or the settings of the RF communications command and RF communications speed. In actual usage, the communications time may change under the influence of the installation environment, system conditions, type of RF Tags, and other factors. Perform sufficient testing in advance.

RF Tag : V780-A-JIME-Z3BLI-10 (Toppan Forms Co., Ltd.)

ID READ (Single-access)

During 6-word (96bit) data readout from the UII (EPC) area

RF communications speed	Communications time
High speed	21 ms
Normal speed	27 ms

DATA READ (Single-access)

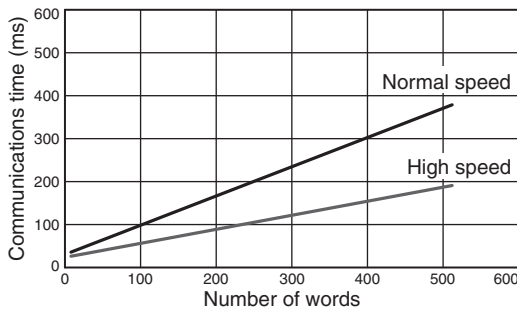

DATA WRITE (Single-access)

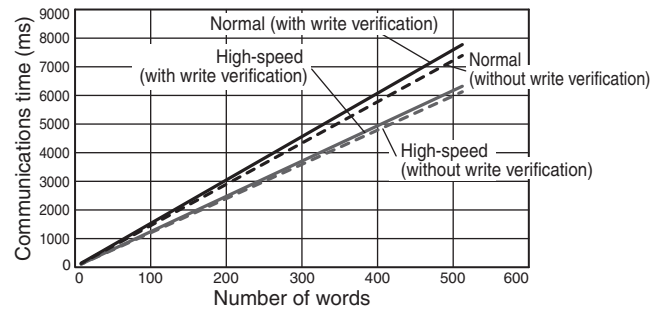

Note: Refer to the V780 Series User's Manual for details.

ID READ (Multi-access)

During 6-word (96bit) data readout from the UII (EPC) area

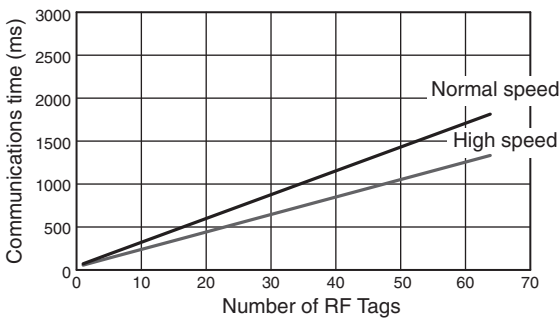

DATA READ (Multi-access)

Reading 32 Words of Data from the User Area

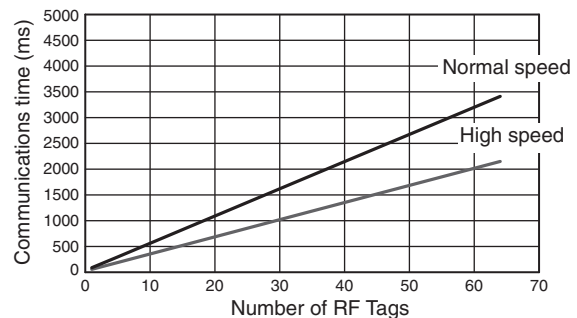

Note: 1. If you set the RF communications speed to high speed, there will generally be a higher rate of collisions in communications with RF Tags than for the normal speed. Therefore, if there are too many RF Tags, the high speed may actually result in longer communications times.
 2. Refer to the V780 Series User's Manual for details.

V780 Series

Characteristic Data V780-HMD68-ETN-MX/V780-HMD68-EIP-MX/V780-HMD68-ETN-MX-S (for Reference Only)

Communications range

The communications range differs depending on the radio regulations of each country. Moreover, the communications range may change under the influence of the ambient environment, type of RF Tags, and the items on which RF Tags are mounted. Sufficiently verify the communications range in advance.

RF Tag : V780-A-JIME-Z3BLI-10 (Toppan Forms Co., Ltd.)
(Back Surface: Metal, with Attachment, V780-A-TA-133-10)

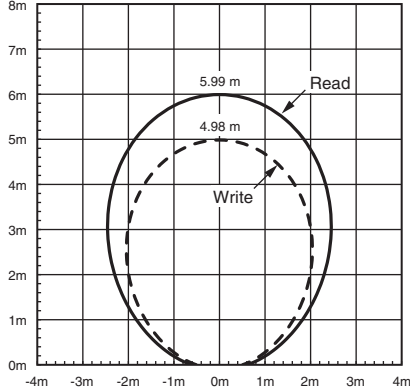

RF Tag Communication Time

The communications time differs depending on the radio regulations of each country, or the settings of the RF communications command and RF communications speed. In actual usage, the communications time may change under the influence of the installation environment, system conditions, type of RF Tags, and other factors. Perform sufficient testing in advance.

RF Tag : V780-A-JIME-Z3BLI-10 (Toppan Forms Co., Ltd.)
ID READ (Single-access)

During 6-word (96bit) data readout from the UII (EPC) area

RF communications speed	Communications time
High speed	21 ms
Normal speed	27 ms

DATA READ (Single-access)

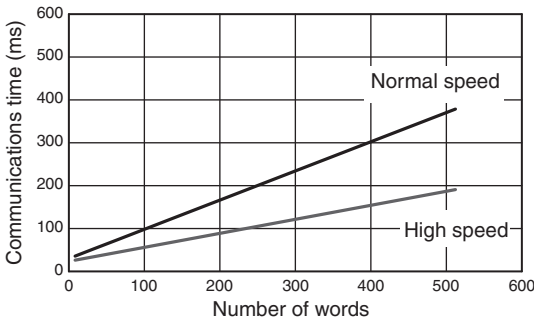

DATA WRITE (Single-access)

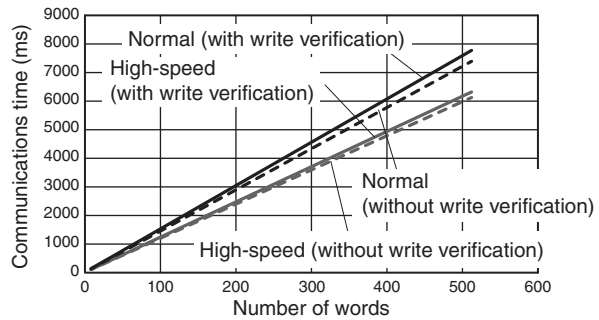

ID READ (Multi-access)

During 6-word (96bit) data readout from the UII (EPC) area

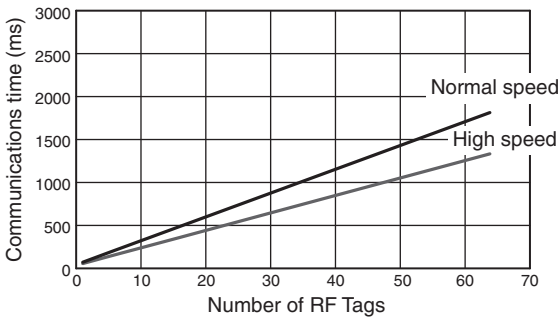

DATA READ (Multi-access)

Reading 32 Words of Data from the User Area

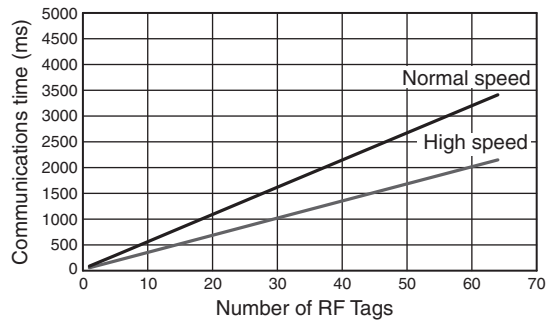

Dimensions

Tolerance class IT16 applies to dimensions in this datasheet unless otherwise specified.

Reader/Writer

V780-HMD68-ETN-□□/V780-HMD68-EIP-□□/V780-HMD68-ETN-□□-S

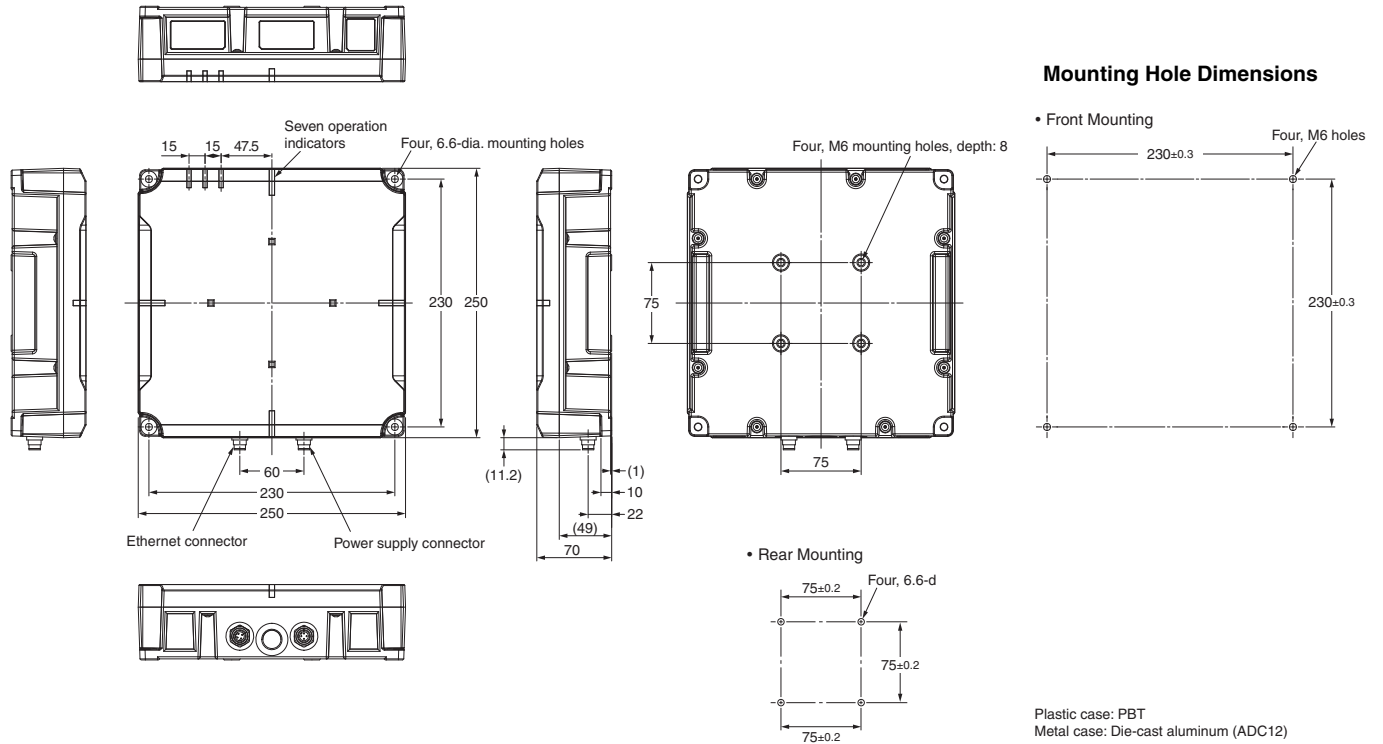

RF Tag

V780-A-JIME-Z3BLI-10 (Toppan Forms Co., Ltd. Model Number: JIME-Z3BLI)

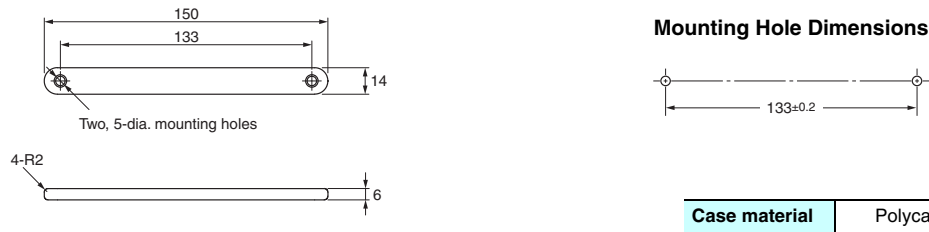

RF Tag Attachment

V780-A-TA-133-10 (Toppan Forms Co., Ltd. Model Number: TA-133)

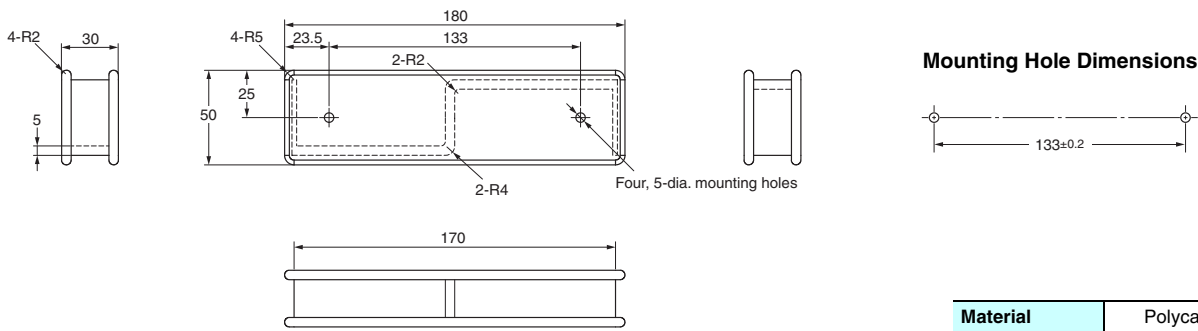

Related Manuals

Cat. No.	Name
Z389-E1	UHF RFID System V780-series Reader/Writer User's Manual (V780-HMD68-ETN-□□)/V780-HMD68-ETN-□□-S
Z402-E1	UHF RFID System V780-series Reader/Writer User's Manual (V780-HMD68-EIP-□□)/V780-HMD68-ETN-□□-S

OMRON AUTOMATION AMERICAS HEADQUARTERS • Chicago, IL USA • 847.843.7900 • 800.556.6766 • automation.omron.com

OMRON CANADA, INC. • HEAD OFFICE

Toronto, ON, Canada • 416.286.6465 • 866.986.6766 • automation.omron.com

OMRON ELECTRONICS DE MEXICO • HEAD OFFICE

Ciudad de México • 52.55.5901.4300 • 01.800.386.6766 • mela@omron.com

OMRON ELECTRONICS DE MEXICO • SALES OFFICE

San Pedro Garza García, N.L. • 81.12.53.7392 • 01.800.386.6766 • mela@omron.com

OMRON ELECTRONICS DE MEXICO • SALES OFFICE

Eugenio Garza Sada, León, Gto • 01.800.386.6766 • mela@omron.com

OMRON ELETRÔNICA DO BRASIL LTDA • HEAD OFFICE

São Paulo, SP, Brasil • 55.11.2101.6300 • www.omron.com.br

OMRON ARGENTINA • SALES OFFICE

Buenos Aires, Argentina • +54.11.4521.8630 • +54.11.4523.8483
mela@omron.com

OTHER OMRON LATIN AMERICA SALES

+54.11.4521.8630 • +54.11.4523.8483 • mela@omron.com

Authorized Distributor:

Controllers & I/O

- Machine Automation Controllers (MAC) • Motion Controllers
- Programmable Logic Controllers (PLC) • Temperature Controllers • Remote I/O

Robotics

- Industrial Robots • Mobile Robots

Operator Interfaces

- Human Machine Interface (HMI)

Motion & Drives

- Machine Automation Controllers (MAC) • Motion Controllers • Servo Systems
- Frequency Inverters

Vision, Measurement & Identification

- Vision Sensors & Systems • Measurement Sensors • Auto Identification Systems

Sensing

- Photoelectric Sensors • Fiber-Optic Sensors • Proximity Sensors
- Rotary Encoders • Ultrasonic Sensors

Safety

- Safety Light Curtains • Safety Laser Scanners • Programmable Safety Systems
- Safety Mats and Edges • Safety Door Switches • Emergency Stop Devices
- Safety Switches & Operator Controls • Safety Monitoring/Force-guided Relays

Control Components

- Power Supplies • Timers • Counters • Programmable Relays
- Digital Panel Meters • Monitoring Products

Switches & Relays

- Limit Switches • Pushbutton Switches • Electromechanical Relays
- Solid State Relays

Software

- Programming & Configuration • Runtime