

Digital Video Recorder

ETV-DVR SERIES



Electronics Line
USA

ETV Digital Video Recorder

4-32 Channel DVR

Enterprise Systems



The ETV series of DVR's from EL-USA provides professional quality, high reliability and an unmatched set of features. The ETV family includes PTZ camera control, system health monitoring, e-mail notification, network logging and advanced searching capabilities. These advanced features make the ETV not only an excellent network accessible DVR, but a sophisticated POS product as well. The ETV DVR can remotely control multiple PTZ cameras, supporting most popular camera protocols including Kalatel, Pelco, Panasonic and more. The ETV family uses the proprietary AZTECH codec image compression technology, producing one of the smallest file sizes in the industry while maintaining excellent image integrity and quality. With its array of remote capabilities, fast frame rates and easy CD backup, ETV implementation guarantees a very fast return on investment.

Benefits & Features

- 4-32 Channel systems
- Smart Search
- IP Camera Interface
- AZTECH Video Codec with Digital Noise Filter
- Remote Monitoring
- Bandwidth Throttle
- Health Monitor
- Unlimited Storage with NAS
- POS-Point of Sale Interface
- VPOSR-Advanced POS Reporter
- Web Server
- Up to 16 CH Audio Recording 2-way Capability
- Advanced PTZ Control
- Managed Updates
- SDK & Access Control Integration

Applications

- Residential, Vacation Home
- Convenience Store, Retail
- Office Building, Bank
- Restaurant, Nightclub, Bar
- Daycare, School Playground

Smart Search

Allows you to pinpoint or specify a single object or place in the camera field of view to search for motion. Whereas searching a camera for movement will return hours of video, pinpointing an area with smart search will reduce that to minutes of video showing motion only in the area you select.



32 Camera Support

Ideal for large installations, a single DVR does it all. A multi-layered interface allows easy access to all your cameras. View 1, 4, 6, 8, 9, 10, 13 or 16 cameras at once and choose any "page" with a right click of the mouse.

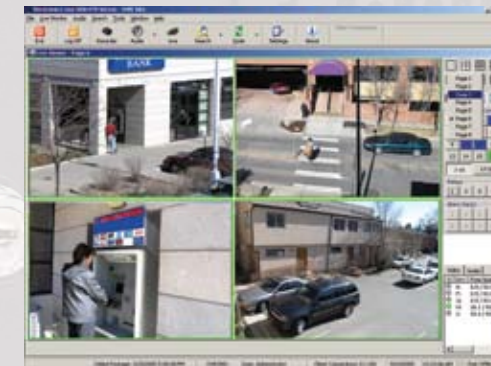

Visual Timeline Search

New to version 4.1, you can choose between a text based event list or switch to a multicolored graphic display of recorded events. Camera detected motion shows up in blue, alarm inputs in red, etc. The graphic allows you to easily identify and rapidly search different types of events.

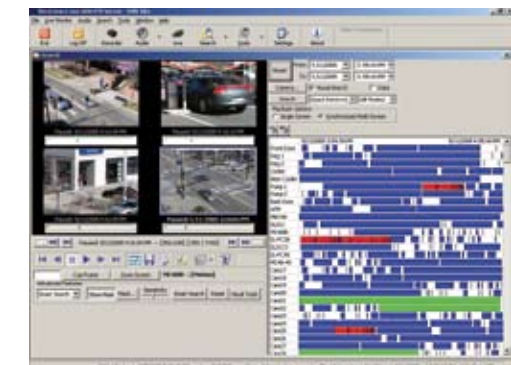

IP Camera Interface

The ETV series supports IP cameras (Network based), bypassing the 'frame grabber' technology of capture card based DVRs. The 'Hybrid DVR' technology is the solution to complex installations where distance or other factors prohibit the use of standard coaxial cable.

New to version 4.2 is the addition of the NVR (Network Video Recorder) series. The NVR uses your existing network exclusively, (No more coax and BNC connectors) allowing for true HD (High Definition) video capture.

With support for ACTI, Axis, IQEye, and other HD cameras, the ETV can record up to 480 FPS (No Recompression) on up to 32 channels, depending on your Network capabilities. (Gigabit network is essential for HD cameras.)

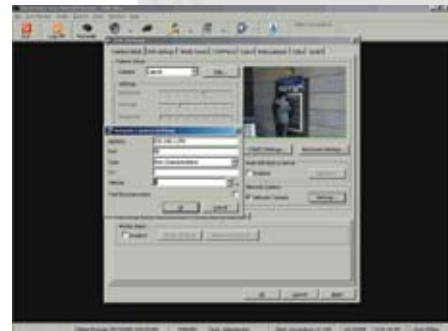

Scheduled Motion Alarms

Fully independent customizable 24/7 scheduling will send local alerts, remote client alerts, trigger onsite alarms, or or e-mail notifications.



Enhanced Audio Features

Up to 16 channels of audio with independently customizable quality and compression settings. Allows live remote monitoring and offers a two way audio chat between the DVR and remote client. Graphic line level input indicator takes the guesswork out of setup.

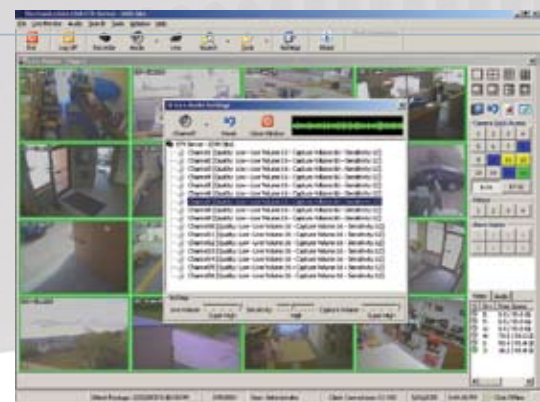

Health Monitor

A remote stand alone application to provide in-depth, detailed reports on every aspect of your DVR's operation, from video loss to CPU usage status. Reports any deviation from expected performance instantly with onscreen pop-up alerts and emails.

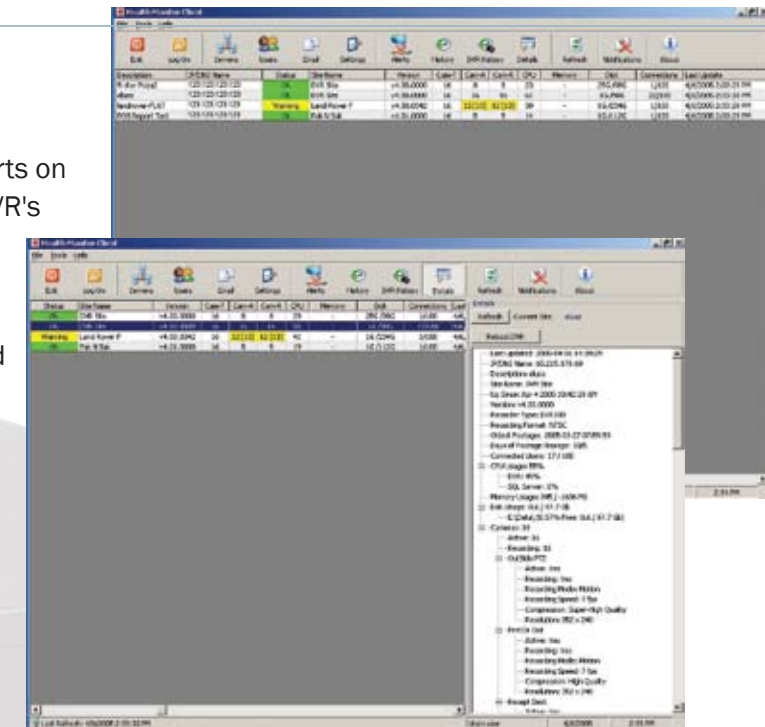

Motion Vector Detection

Allows you to trigger a motion alarm whenever an object moves in the wrong direction through the camera field of view. (Such as a person entering an 'Exit Only' door).

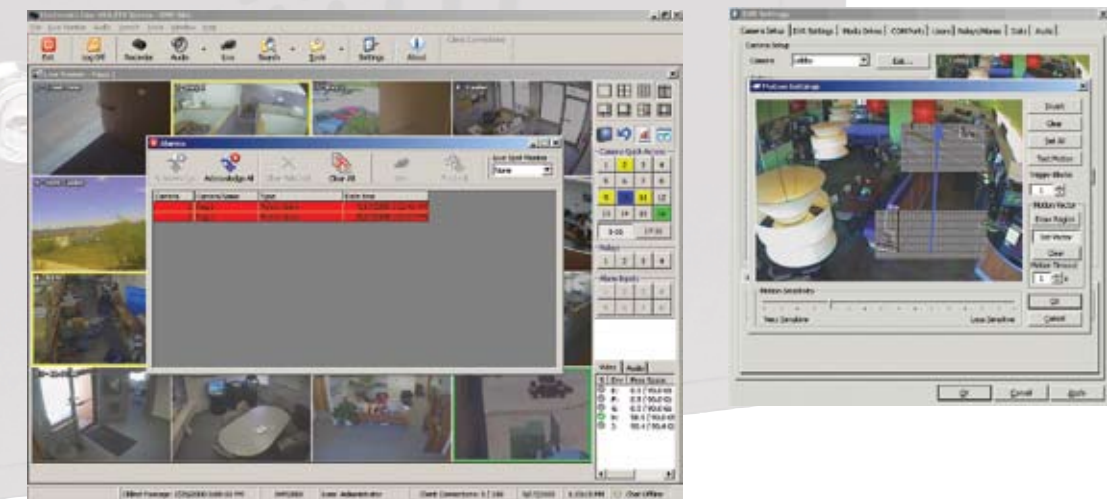

Point of Sale

The ETV Enterprise Systems are specifically designed with the retail environment in mind to provide complete solutions for POS (Point of Sale) and Retail Loss Prevention. The ETV POS software allows you to set a variety of parameters for a Manual Search Query. For instance, you can monitor the sale of Lottery tickets with any assigned search criteria including, Item code, value, quantity, cashier, register number, and receipt number to quickly retrieve data and related video.

Enter your search criteria into the Predefined Custom Search section to save and repeat the same search without having to re-enter the information.



POS Reporter

The most powerful tool of its kind, the V-POS Reporter is your Virtual Loss Prevention Officer. Scanning every transaction from every register 24 hours a day, the V-POS alerts you to potential losses as they occur.

Use real time notification, or use the flexible schedule to send reports every hour, every day, or even weekly. Installed on the ETV, the V-POS Reporter will provide on screen pop-up alerts, send email alerts, or trigger alarm outputs. Installing the V-POS Reporter at your home or corporate location gives you the advantage of the same powerful exception reporting tools as well as one click access to related video data.

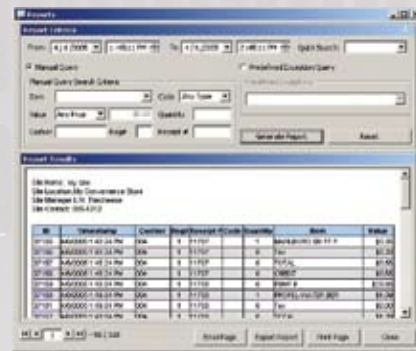
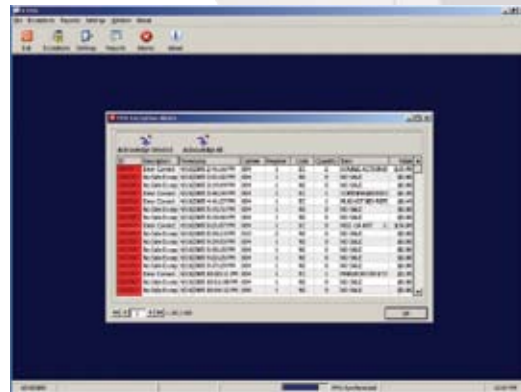

POS Interface

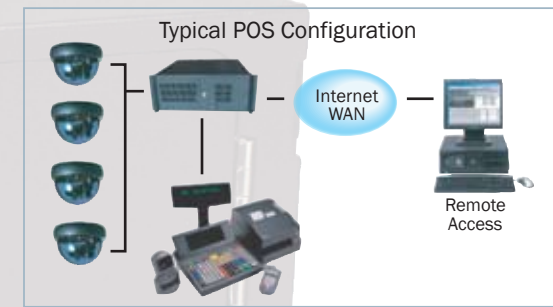

Integrated with a wide variety of cash registers and POS softwares, the ETV series provides a complete solution for transaction tracking. Easy point and click interface lets you search for video by entering transaction details. Use the powerful exception based search to quickly locate discrepancies in your daily sales, such as voids and no sales.

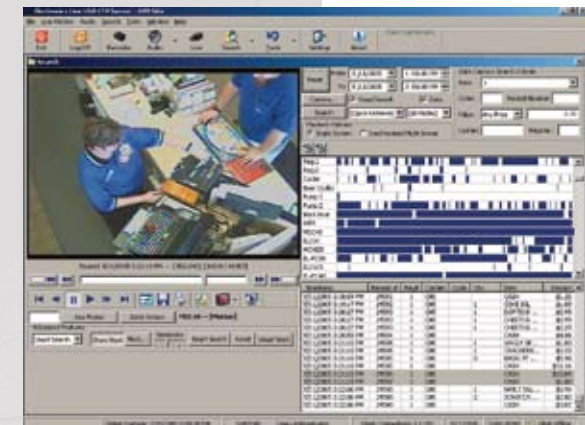

Multiple Codec Support

The ETV series uses the proprietary Aztech codec to allow for pre-compression processing. By removing 'noise' inherent in video signals before compressing the image, the ETV records a superior picture at a fraction of the file size. New in version 4.2 is the ability to record with the Aztech engine or the industry standard MPEG4 compression. The Aztech engine allows you to output data in MPEG4 or MJPEG syntax where a smoother quality image is required. (Such as a touring PTZ camera). The MPEG4 engine allows for adjustable Key Frame rates as well as H.263 quantization for maximum compression rates when image quality is not as important. With fully customizable compression, quality, resolution, and frame rates (from real time 30fps to ultra low 1 frame per half hour) the ETV series can be fine tuned to get maximum results from any recording situation.

AZTECH Video CODEC

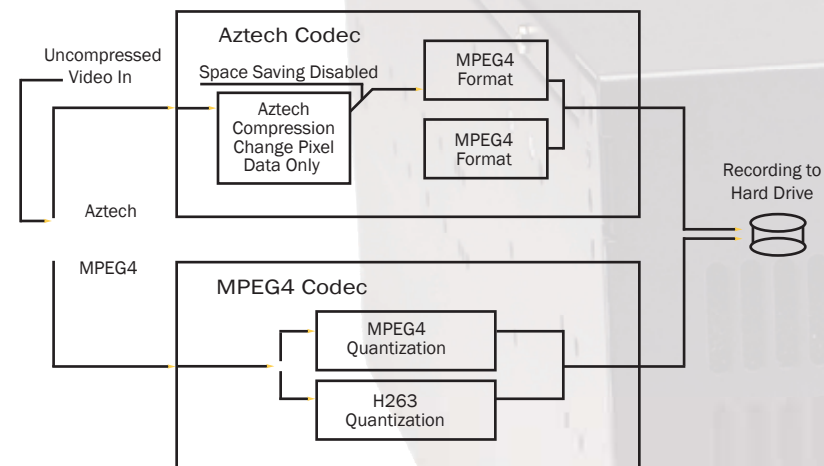

Multi Level Site Map

For monitoring stations or any user with a large number of DVR locations. You can start with a map of the entire US and define maps for each state, city, street and building. Define rooms in each building showing individual camera locations. Move from map to map with a single click or click on a camera icon to show live video from that camera.



Export Auditing

Protects your data from unauthorized distribution. When enabled, requires the user to input a user name, password and other information before any recorded data can be transferred to a backup media. This data is stored in a log file that can be reviewed by the system administrator.



Remote Viewing Functions

- Connection by cable modem, DSL, LAN/WAN, Satellite
- Remote software can be loaded on as many remote computers as necessary
- Multiple users can connect simultaneously (bandwidth limited)
- Multiple levels of security for remote connection
- Allow or Deny users access to some or all settings
- View live video from 1 to 16 DVRs simultaneously
- View 1, 4, 6, 8, 9, 10, 13, or 16 cameras
- Review and save recorded images remotely
- Smart Search locally or remotely
- Control multiple PTZ cameras remotely
- Alarm inputs can trigger DVR to connect to remote PC & send alarm to the remote client
- Remote control of inputs & outputs on DVR
- Easy save to CD-ROM
- Data integrated search and playback
- POS Upgrade allows ETV/POS DVRs to integrate with cash registers (call for protocol availability). Superior POS Integration allows local & remote search of video & data as well as POS data reporting.

Typical Configuration

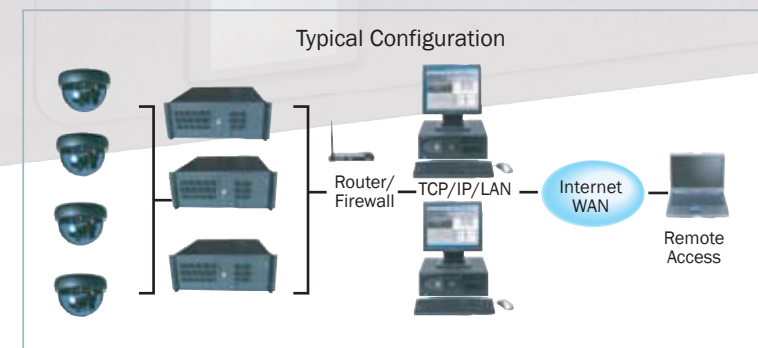

PTZ Control

Supports a wide variety of Pan Tilt Zoom cameras. Now includes 'Click in Picture' movement control as well as the standard 'Virtual Joystick'.

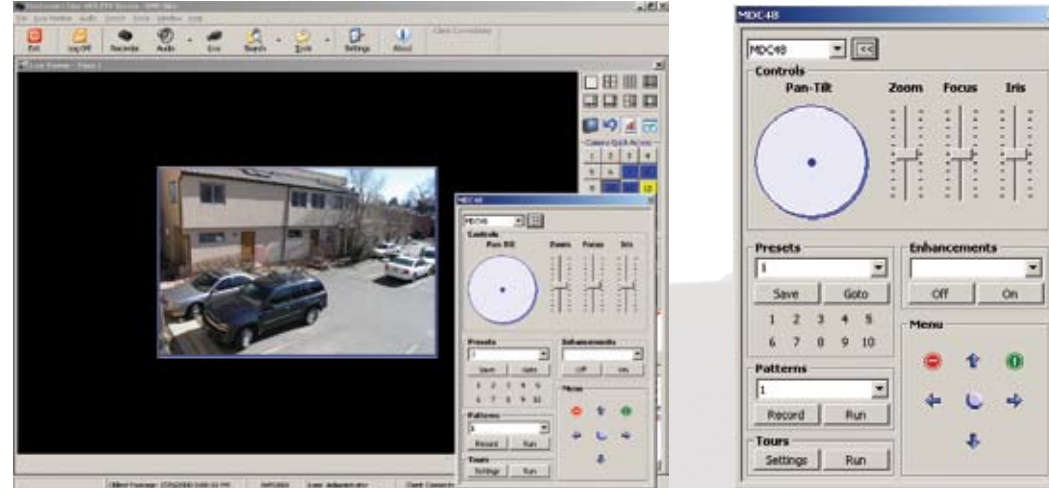

Select ETV DVR Series

ETV- <input type="text"/> - <input type="text"/> -(Audio Optional)- <input type="text"/>	
Frames per Second	Storage Hard Drives
30 FPS	120 GB
60 FPS	250 GB
120 FPS	500 GB
240 FPS	800 GB
Camera	1,000 GB
4 Camera Inputs	1,200 GB
16 Camera Inputs	1,600 GB
32 Camera Inputs	

All models come with 2-way audio standard.
Multi-audio configurations can have up to 16 channel capability

Optional Equipment for ETV Series

ETV- Alarm 8/4	8 input 4 output Alarm card
ETV- Alarm 8/4-x2	16 input 8 output Alarm card
ETV-POS	Point of Sale Software Upgrade
EL-POS-Kit	Point of Sale Integration Cable for Printer
EL-POS-Kit/USB	Point of Sale Integration Cable with USB for Printer
EL-POS-Pole	Point of Sale Integration Cable for Pole Display
ETV-Health Monitor	Remote Software
ETV-Advanced Point of Sale	Offered
HERA Card	Gives up to 16 Audio inputs
B & B 485P TBR	232 to 485 converter for P/T/Z control
EL-DVR-Power Kit	325VA UPS and Power Conditioner
RADMIN	PC Remote Connection Software

Technical Specifications

Computer Specifications

- Windows 2000 & XP Operating System
- Pentium 4 Processor 2.4Ghz 533MHz FSB
- 1 GB RAM
- 52x CDRW drive
- ATI Radeon 9250 128mb
- 10/100/ 1000 Base network card

* Midlevel ETV 120-16 system specs

Electrical/Video/Audio

Input Voltage	100-240 VAC, 50/60 Hz
Power Consumption	20-300 Watts
Video Standard	NTSC or PAL
Video Transmission	Proprietary
Video Formats	Codec Proprietary, AVI
Video Resolution	352 x 240, 704 x 480
File Size (Approx.)	2-6k, @ 352 x 240
Recording Speed	30, 60, 120, 240 FPS

Video/Audio Inputs/Outputs

Video Storage	120, 250, 500...Up to 1.6 TB
Video Inputs	4, 16, 32
Video Outputs	3 (1 VGA, with up to 2 Composite)
Alarm Inputs	16 (Optional)
Alarm Outputs	8 (Optional)
Printer Output	Parallel USB
Audio Inputs	1 - 16 (Optional)
Audio Output	1 line level/1 speaker

Mechanical Connectors

- Keyboard & Mouse (PS-2)
- (4) USB-2 Ports
- VGA
- RJ-45 (10/100 Ethernet)
- 1/8" Line Out/Mic In/Spkr Out
- DB9-RS-232 (More Optional)
- RCA Composite Output
- LPT Printer Port
- Sensor Interface (Optional)
- 4-32 BNC Video Input Connectors

General

Operating Temperature	40° F - 80° F (5° C - 40° C)
Max. Relative Humidity	80%
Dimensions (WxDxH)	13.5" x 14.5" x 5.75" (342.9mm x 368.3mm x 146.05mm)
Rack Mount (WxDxH)	19" x 18" x 7" (482.6mm x 457.2mm x 177.8mm)
Unit Weight	28 lbs (13 kg)
Unit w/Rack Weight	65 lbs (29.48 kg)

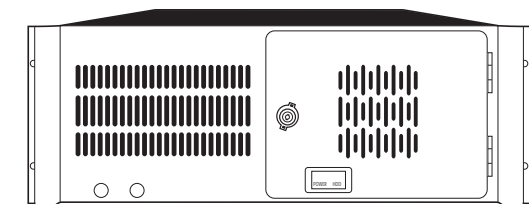
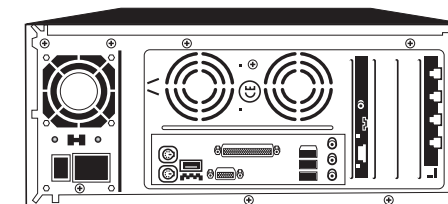



Electronics Line
USA

Security and Beyond

Electronics Line USA

To Contact an Electronics Line USA Sales Representative Call 1.800.683.6835 • Electronics Line USA • 5637 Arapahoe Avenue Boulder, Colorado 80303 • www.el-usa.com

Printed in Israel ZP0084