

SG4 FIELDBUS



First safety light curtain with integrated openSAFETY over POWERLINK

Fast and easy installation, configuration and maintenance

Complete diagnostic and monitoring available over the communication bus

Basic models: classic functions available

Advanced models: each beam status safe information available

- Two M12 connectors on receiver side for POWERLINK connection
- M8 connectors on emitter and receiver for power supply
- Up to 19m operating range and 1800m protected height
- Finger, hand and body protection
- Compact dimensions (35 x 42 mm section)
- POWERLINK node address configurable with selector switches
- Functions available in combination with B&R safety controller SL and SLX: auto/manual restart, EDM, Muting, Override
- Functions available for advanced models in combination with B&R safety controller SL: fixed blanking, floating blanking, partial and dynamic muting, warning areas, measurement



APPLICATIONS

- Automatic and semi-automatic machines and lines
- Primary packaging machinery (packing, filling, labelling, etc...)
- Cutting machinery
- Bending and metal-working machines
- Material handling machinery
- Palletizers and depalletizers
- Material handling
- Robots cells

INDUSTRIE

- Food & Beverage, Metalworking, Automotive, Wood, Ceramics

	FINGER	HAND	ARM	BODY
Type 2				
Type 4	x	x		x

SG4-14-015-OP-A



SG4-S2-060-OP-B

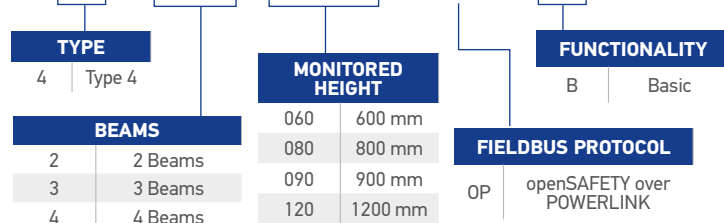

TECHNICAL DATA

SG4 FIELDBUS

	Finger and Hand resolution [SG4-xx-xxx-OP-x]	Body detection [SG4-Sx-xxx-OP-x]
GENERAL DATA		
Type (EN61496-1)		4
PL (EN ISO 13849-1)		e
SIL (IEC 61508)		3
Resolution	14 mm [SG4-14-xxx-OP-x] 30 mm [SG4-30-xxx-OP-x]	2 beams [SG4-S2-xxx-OP-x] 3 beams [SG4-S3-xxx-OP-x] 4 beams [SG4-S4-xxx-OP-x]
Protected height	150 ... 1800 mm (with 150 mm steps)	600 / 800 / 900 / 1200 mm
Operating distance	0.2 ... 6 m [SG4-14-xxx-OP-x] 0.2 ... 19 m [SG4-30-xxx-OP-x]	0.2 ... 19 m
ELECTRICAL DATA		
Power supply (Vdd)		24 Vdc ± 20%
Consumption (Transmitter)		3 W max
Consumption (Receiver)		5 W max
Response time		see response time table
Power supply cable length		50 m max
Ethernet cable length		100 m max
MECHANICAL AND ENVIRONMENTAL DATA		
Operating temperature		0 ... +50 °C
Humidity		15 ... 95 % (no condensation)
Mechanical protection		IP 65 (EN 60529)
Housing material		Painted aluminium, Polycarbonate
Window material		PMMA

FUNCTIONS

SG4 FIELDBUS can only be used in combination with a safety PLC to which it transmits safety information about its status through openSAFETY over POWERLINK.
BASE models transmit only their ON/OFF status, ADVANCED models transmit also each beam status.
Using appropriate functional blocks or instructions inside the safety PLC it is possible to implement the following functions:

BASE MODELS [SG4-xx-xxx-OP-B] ADVANCED MODELS [SG4-xx-xxx-OP-A]	Automatic/Manual restart
	External Device Monitoring
ADVANCED MODELS [SG4-xx-xxx-OP-A]	Total Muting
	Partial muting
	Auto dynamic Partial muting
	Fixed Blanking
	Floating Blanking
	Measurement

MODEL	RESPONSE TIME (ms)
SG4-14-015-OP-B	19
SG4-14-030-OP-B	22
SG4-14-045-OP-B	25
SG4-14-060-OP-B	29
SG4-14-075-OP-B	31
SG4-14-090-OP-B	35
SG4-14-105-OP-B	38
SG4-14-120-OP-B	41
SG4-14-135-OP-B	44
SG4-14-150-OP-B	47
SG4-14-165-OP-B	51
SG4-14-180-OP-B	54
SG4-30-015-OP-B	19
SG4-30-030-OP-B	21
SG4-30-045-OP-B	22
SG4-30-060-OP-B	24
SG4-30-075-OP-B	25
SG4-30-090-OP-B	27
SG4-30-105-OP-B	29
SG4-30-120-OP-B	31
SG4-30-135-OP-B	32
SG4-30-150-OP-B	34
SG4-30-165-OP-B	36
SG4-30-180-OP-B	38
SG4-S2-060-OP-B	24
SG4-S3-080-OP-B	27
SG4-S4-090-OP-B	27
SG4-S4-120-OP-B	31

NOTE

The response time reported in this table is the part of the communication time depending only by the light curtain.
Additional time must be added, depending on configurable parameters of the POWERLINK network and safety PLC.

CONNECTIONS

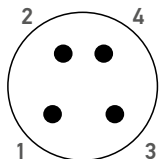
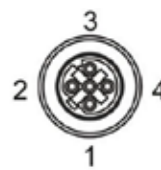
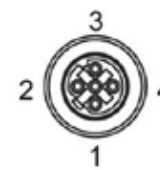
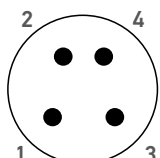
	CN1	CN2	CN3
RECEIVER	 <p>POWER CONNECTOR: M8 4-pin male</p>	 <p>POWERLINK CONNECTOR: M12 D-coded female Ethernet</p>	 <p>POWERLINK CONNECTOR: M12 D-coded female Ethernet</p>
EMITTER	 <p>POWER CONNECTOR: M8 4-pin male</p>		

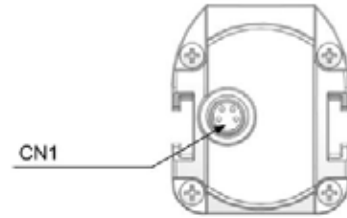
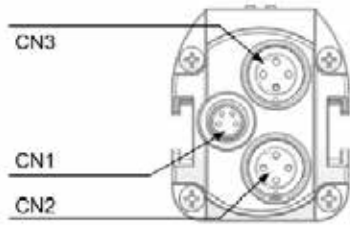

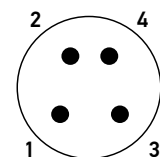
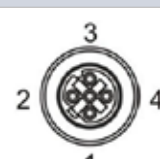
CN1	SIGNAL	DESCRIPTION
1	24 Vdc (BROWN)	 <p>POWER CONNECTOR</p>
2	NOT USED (WHITE)	
3	0 Vdc (BLUE)	
4	NOT USED (BLACK)	
CN2	SIGNAL	DESCRIPTION
1	TxD+, transmit data +	 <p>ETHERNET POWERLINK PORT 1</p>
2	RxD+, receive data +	
3	TxD-, transmit data -	
4	RxD-, receive data -	



INDICATORS

Receiver



Emitter



LED	COLOR	NAME	FUNCTION (NORMAL OPERATION)	FUNCTION (ERROR)
	Red/Green	BEAM STATUS	Red On: At least one beam intercepted Green On: All beams free	Red On
	Yellow	SYNC BEAM	On: First beam intercepted or not aligned	Blinking: OPTIC, uP or openSAFETY ERROR
	Yellow	LAST BEAM	On: Last beam intercepted or not aligned	
M	Red	MASTER uP STATUS	Off: Normal operation Blinking: Boot or pre-op	On: Error on MASTER uP Boot or Pre-op
P	Red/Green	POWERLINK STATUS	Green On: normal operation Green blinking: pre-op	Red On: Ethernet Powerlink Error
1	Green	EPL PORT 1 LINK	On: there is a link Blinking: there is activity on this link	N/A
2	Green	EPL PORT 2 LINK	On: there is a link Blinking: there is activity on this link	N/A
S	Red	SLAVE uP STATUS	Off: Normal operation Blinking: Boot or pre-op	On: Error on SLAVE uP Boot Pre-op

DIMENSIONS

OVERALL DIMENSIONS SG4 FIELDBUS

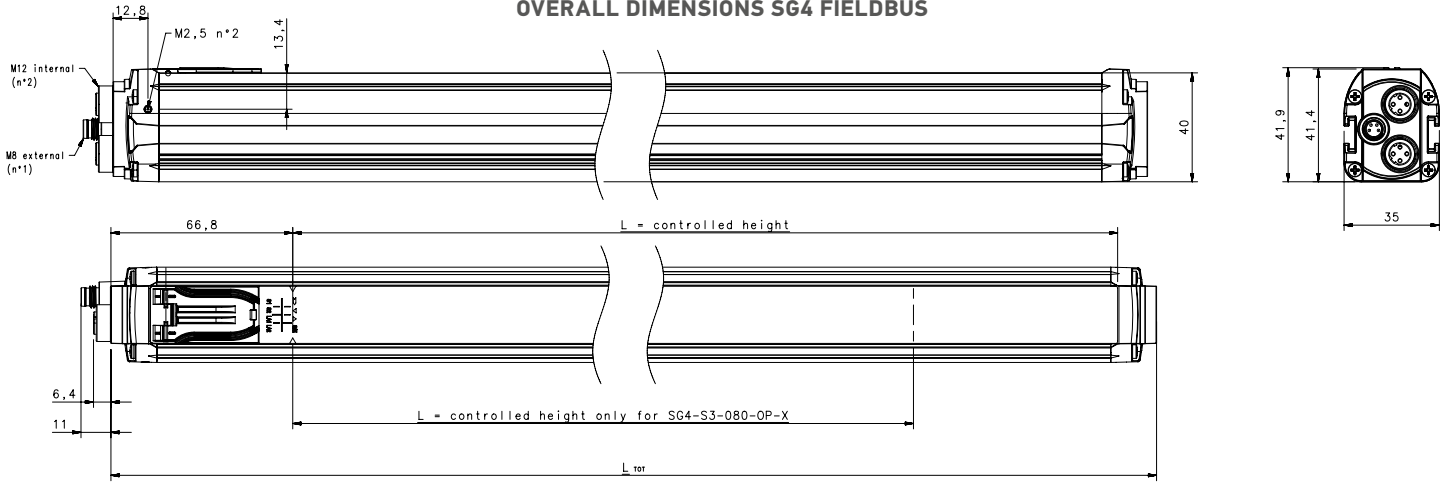

OVERALL DIMENSIONS SG4 FIELDBUS WITH ST-KSTD FIXING BRACKET

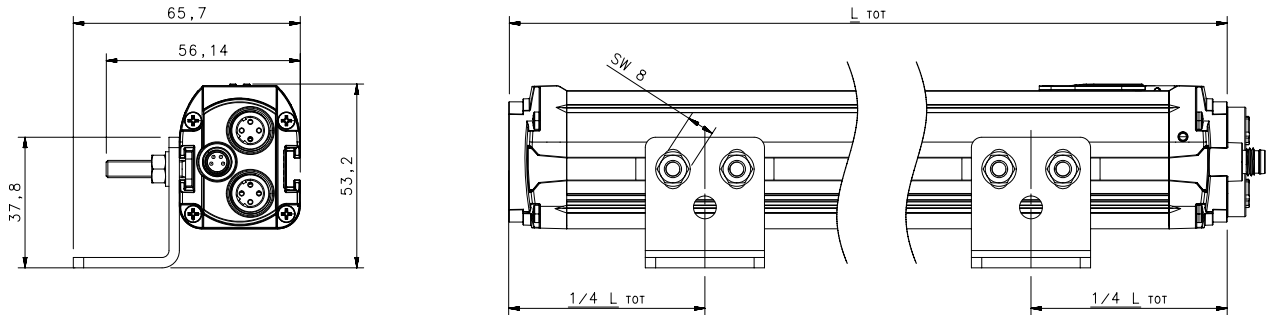

OVERALL DIMENSIONS SG4 FIELDBUS WITH ST-K4-ROT-OP FIXING BRACKET

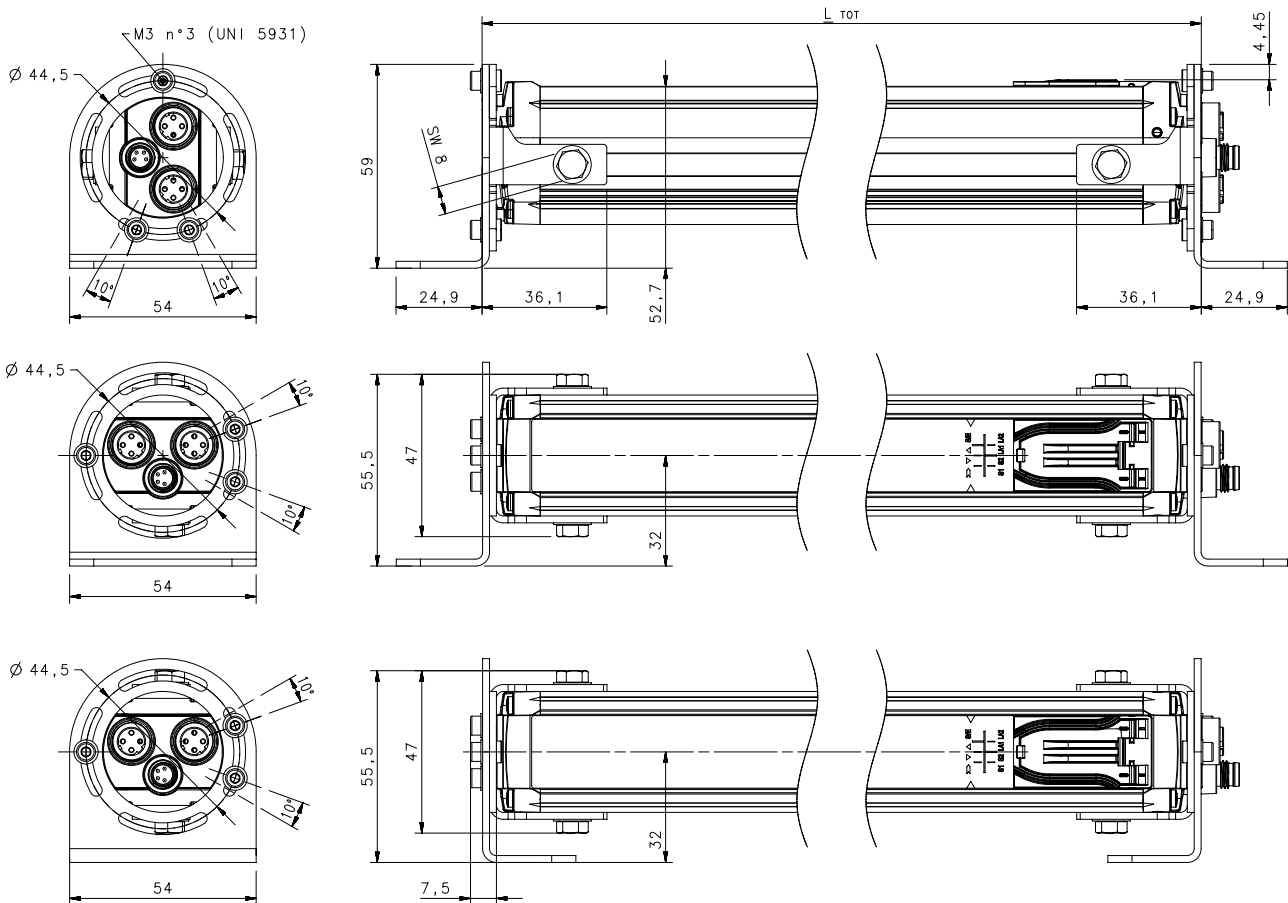

MODEL SELECTION AND ORDER INFORMATION

	Basic functionality [SG4-xx-xxx-OP-B] [SG4-Sx-xxx-OP-B]	Order Number	Advanced functionality [SG4-xx-xxx-OP-A]	Order Number
FINGER PROTECTION	SG4-14-015-OP-B	957901770	SG4-14-015-OP-A	957902050
	SG4-14-030-OP-B	957901780	SG4-14-030-OP-A	957902060
	SG4-14-045-OP-B	957901790	SG4-14-045-OP-A	957902070
	SG4-14-060-OP-B	957901800	SG4-14-060-OP-A	957902080
	SG4-14-075-OP-B	957901810	SG4-14-075-OP-A	957902090
	SG4-14-090-OP-B	957901820	SG4-14-090-OP-A	957902100
	SG4-14-105-OP-B	957901830	SG4-14-105-OP-A	957902110
	SG4-14-120-OP-B	957901840	SG4-14-120-OP-A	957902120
	SG4-14-135-OP-B	957901850	SG4-14-135-OP-A	957902130
	SG4-14-150-OP-B	957901860	SG4-14-150-OP-A	957902140
	SG4-14-165-OP-B	957901870	SG4-14-165-OP-A	957902150
	SG4-14-180-OP-B	957901880	SG4-14-180-OP-A	957902160
HAND PROTECTION	SG4-30-015-OP-B	957901890	SG4-30-015-OP-A	957902170
	SG4-30-030-OP-B	957901900	SG4-30-030-OP-A	957902180
	SG4-30-045-OP-B	957901910	SG4-30-045-OP-A	957902190
	SG4-30-060-OP-B	957901920	SG4-30-060-OP-A	957902200
	SG4-30-075-OP-B	957901930	SG4-30-075-OP-A	957902210
	SG4-30-090-OP-B	957901940	SG4-30-090-OP-A	957902220
	SG4-30-105-OP-B	957901950	SG4-30-105-OP-A	957902230
	SG4-30-120-OP-B	957901960	SG4-30-120-OP-A	957902240
	SG4-30-135-OP-B	957901970	SG4-30-135-OP-A	957902250
	SG4-30-150-OP-B	957901980	SG4-30-150-OP-A	957902260
	SG4-30-165-OP-B	957901990	SG4-30-165-OP-A	957902270
	SG4-30-180-OP-B	957902000	SG4-30-180-OP-A	957902280
BODY PROTECTION	SG4-S2-060-OP-B	957902010	--	--
	SG4-S3-080-OP-B	957902020	--	--
	SG4-S4-090-OP-B	957902030	--	--
	SG4-S4-120-OP-B	957902040	--	--

CABLES

POWER SUPPLY CABLES			
	MODEL	LENGTH (m)	ORDER CODE
M8 AXIAL CONNECTOR	CS-B1-02-G-03	3	95A251420
	CS-B1-02-G-05	5	95A251430
	CS-B1-02-G-07	7	95A251440
	CS-B1-02-G-10	10	95A251480
M8 RADIAL CONNECTOR	CS-B2-02-G-03	3	95A251450
	CS-B2-02-G-05	5	95A251460
	CS-B2-02-G-07	7	95A251470
	CS-B2-02-G-10	10	95A251530
POWERLINK CABLES			
M12 AXIAL - RJ45	CAB-ETH-M01	1	93A051346
	CAB-ETH-M03	3	93A051347
	CAB-ETH-M05	5	93A051348
	CAB-ETH-M10	10	93A051391
M12 AXIAL - M12	ETH CABLE M12-M12 1M	1	93A050065
	ETH CABLE M12-M12 3M	3	93A050066
	ETH CABLE M12-M12 5M	5	93A050067

ACCESSORIES

	SG4 FIELDBUS [SG4-14-xxx-0P-x] [SG4-30-xxx-0P-x]	SG4 FIELDBUS [SG4-Sx-xxx-0P-x]
BRACKETS		
Standard angled brackets (included)		ST-KSTD
Antivibration support (4 pcs / 6 pcs)*		ST-K4AV ST-K6AV
Plastic brackets (4 pcs / 6 pcs)*		ST-KP4MP ST-KP6MP
Orientable brackets (4 pcs)		ST-K4ROT-OP
STANDS		
Protective Stands		SG-PSB series
Stand Plate for SG-PSB		SG-P
Protective Stands Mounting Brackets (4 pcs / 6 pcs)*		ST-PS4-SG-SE ST-PS6-SG-SE
Floor columns		SE-S Series
MIRRORS		
Protective stands with single mirrors	--	SG-PSM series
Deviating Mirrors		SG-DM Series
Deviating Mirrors mounting kit for SG-PSB		ST-PS-DM
Mirror Mounting Bracket		ST-DM
ALIGNMENT TOOL		
LASER Pointer		SG-LP

NOTES

* Use 6 brackets for light curtains with length >= 1200 mm

COMPATIBILITY WITH B&R HARDWARE AND SOFTWARE

Due to the characteristics of the functional blocks that have been developed by B&R in order to communicate with DATALOGIC SG4 FIELDBUS safety light curtains, always check to have the following versions or newer:

1) SG4 Fieldbus Base:

HW: SafeLOGIC SL81xx, SLXxxx

SW: SafetyRelease 1.10, SafeDESIGNER 4.2.x, Automation Studio 4.2.8.x, SL Upgrades 1.10.x.x

2) SG4 Fieldbus Advanced:

HW: SL81xx only

SW: SafetyRelease 1.10, SafeDESIGNER 4.3.3, Automation Studio 4.3.3, SL Upgrades 1.10.2.x

Rev. 07, 05/2020

DATALOGIC PRODUCT OFFERING



Sensors



Hand Held
scanners



Mobile Computers



Laser Marking
Systems



Vision
Systems



Stationary
Industrial
Scanners



Safety Laser
Scanner



RFID Systems