

AXIS P72 Video Encoder Series

Full-featured, cost-effective video encoders with H.264.

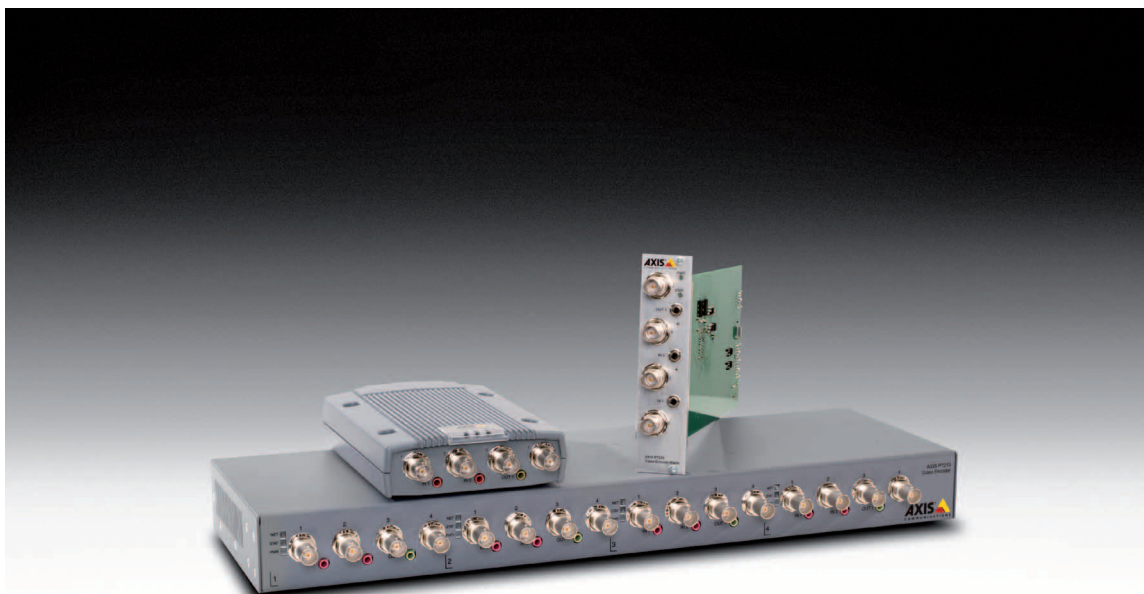

- > Full frame rate
- > Simultaneous H.264 and Motion JPEG streams
- > Edge storage
- > High resolution quad-view
- > Two-way audio
- > Power over Ethernet

AXIS P72 Video Encoder Series offers powerful, full-featured and efficient integration of analog cameras into an IP-based video surveillance system and is ideal for locations such as gas stations, convenience stores and small offices.

AXIS P72 Series enables a cost-effective way to gain all the benefits of professional network video without discarding existing analog investments. The video encoders offer advanced network capabilities with great video performance and excellent audio quality.

AXIS P72 Video Encoder Series comprises two 4-channel models and one 16-channel model providing H.264 and Motion JPEG streams. The support for H.264 offers a superb video compression format that drastically reduces bandwidth and storage requirements without compromising image quality.

All video encoders in AXIS P72 Series offer one H.264 and one Motion JPEG stream per channel at full frame rate in all resolutions up to D1 (720x480 NTSC or 720x576 PAL).

AXIS P72 Series offers intelligent video capabilities such as video motion detection, active tampering alarm and two-way audio with audio detection.

AXIS P72 Series includes support for Power over Ethernet (IEEE 802.3af), which enables the encoders to receive power through the network cable. All Axis video encoder products also provide pan, tilt and zoom support, enabling control of analog PTZ cameras. The standalone versions also have microSDHC memory card slots for edge storage.



Technical specifications – AXIS P7214/P7210 Video Encoders

Video encoder		System integration	
Models	AXIS P7214: 4-channel video encoder AXIS P7210: 16-channel video encoder	Application Programming Interface	Open API for software integration, including VAPIX® from Axis Communications, available at www.axis.com ONVIF, specification available at www.onvif.org
Video compression	H.264 (MPEG-4 Part 10/AVC) Baseline and Main Profile Motion JPEG	Intelligent video	Video motion detection, active tampering alarm, audio detection
Resolutions	176x120 to 720x576, 176x120 to 1536x1152 for quad view	Alarm triggers	Intelligent video, external inputs, video loss
Frame rate H.264	30/25 (NTSC/PAL) fps 15 fps in quad view in full resolution	Alarm actions	File upload via FTP, HTTP and email; notification via email, HTTP and TCP; external output activation; video and audio recording to edge storage; pre- and post-alarm video buffering, PTZ preset, play audio clip
Frame rate Motion JPEG	30/25 (NTSC/PAL) fps 15 fps in quad view in full resolution	Pan/Tilt/Zoom	Wide range of analog PTZ cameras supported (drivers available for download at www.axis.com) AXIS P7214: Support for one PTZ driver AXIS P7210: Support for one PTZ driver in each group of 4 channels 100 presets/camera, guard tour, PTZ control queue Supports Windows compatible joysticks
Video streaming	One individually configured H.264 and one Motion JPEG stream per channel at full frame rate. More streams if identical or limited in frame rate/resolution Controllable frame rate and bandwidth VBR/CBR H.264	General	
Image settings	Compression, color, brightness, contrast Rotation: 90°, 180°, 270° Aspect ratio correction, mirroring of images, text and image overlay, privacy mask, enhanced deinterlace filter, video termination, antialiasing, temporal noise filtering	Casing	AXIS P7214, P7210: Standalone, metal casing AXIS P7214: Wallmount AXIS P7210: Rackmount or wallmount
Audio		Processor and memory	AXIS P7214: ARTPEC-4, 512 MB RAM, 128 MB Flash AXIS P7210: Same as above x 4
Audio streaming	Two-way, full duplex and half duplex (mic/line input 1/line output). Two-way, full duplex and half duplex (mic/line input 2/line output)	Power	AXIS P7214: 8-20 V DC, max 8W; Power over Ethernet IEEE 802.3af Class 3 AXIS P7210: 8-20 V DC, max 32W; 4 x Power over Ethernet IEEE 802.3af Class 3
Audio compression	In: AAC-LC 8 or 16 kHz 8-64 kbit/s, G.711 μ-law PCM 8 kHz 64 kbit/s, G.726 ADPCM 8 kHz 32 kbit/s or 24 kbit/s Out: G.711 μ-law PCM 8 kHz 64 kbit/s, μ-law PCM 16 kHz 128 kbit/s, G.726 ADPCM 8 kHz 32 kbit/s or 24 kbit/s	Connectors	AXIS P7214, P7210: DC input terminal block AXIS P7214: 4 x analog composite video BNC inputs RJ-45 10BASE-T/100BASE-TX PoE Terminal block for four configurable external inputs/outputs Terminal block for RS-485/422 (full duplex) 2 x 3.5mm jacks for microphone or line input (mono) 3.5mm jack for audio output (mono) AXIS P7210: Same as above x 4
Audio input/output	External microphone input or line input Line level output Audio streaming, record (AU) and play uploaded (WAV, AU) clips AU (G.711 μ-law 8-bit 8/16 kHz mono), WAV (PCM 16-bit 8/16 kHz mono)	Edge storage	AXIS P7214: 1 x microSDHC AXIS P7210: 4 x microSDHC
Network		Operating conditions	0 °C – 50 °C (32 °F – 122 °F) Humidity 20 – 80% RH (non-condensing)
Security	Password protection, IP address filtering, HTTPS* encryption, IEEE 802.1X* network access control, digest authentication, user access log	Approvals	EN 55022 Class B, EN 61000-3-2, EN 61000-3-3, EN 55024, EN61000-6-1, EN61000-6-2, EN 60950-1, C-tick AS/NZS CISPR 22, FCC Part 15 Subpart B Class B, ICES-003 Class B, VCCI Class B, KCC Class B, UL/IEC/EN 60950-1
Supported protocols	IPv4/v6, HTTP, HTTPS*, IEEE 802.1X*, QoS layer 3 DiffServ, FTP, SMTP, Bonjour, UPnP, SNMPv1/v2c/v3(MIB-II), DNS, DynDNS, NTP, RTSP, RTP, TCP, UDP, IGMP, RTCP, ICMP, DHCP, ARP, SOCKS	Weight	AXIS P7214: 570 g (1.26 lb.) AXIS P7210: 2540 g (5.6 lb.)
		Included accessories	Power supply, mounting and connector kits, Installation Guide, CD with installation and management tools, software and User's Manual, Windows decoder user licenses

* This product includes software developed by the OpenSSL Project for use in the OpenSSL Toolkit. (www.openssl.org)

More information is available at www.axis.com

Optional accessories

AXIS T8310 Video Surveillance Control Board



AXIS T91A02 Din Rail Clip 86mm (AXIS P7214 only)



For information on Axis Camera Station and video management software from Axis' Application Development Partners, see www.axis.com/products/video/software/

Technical specifications – AXIS P7224 Video Encoder Blade

Video encoder		System integration	
Models	AXIS P7224: 4-channel video encoder blade	Application Programming Interface	Open API for software integration, including VAPIX® from Axis Communications, available at www.axis.com ONVIF, specification available at www.onvif.org
Video compression	H.264 (MPEG-4 Part 10/AVC) Baseline and Main Profile Motion JPEG	Intelligent video	Video motion detection, active tampering alarm, audio detection
Resolutions	176x120 to 720x576, 176x120 to 1536x1152 for quad view	Alarm triggers	Intelligent video, external inputs, video loss
Frame rate H.264	30/25 (NTSC/PAL) fps 15 fps in quad view in full resolution	Alarm actions	File upload via FTP, HTTP and email; notification via email, HTTP and TCP; external output activation; video and audio recording to edge storage; pre- and post-alarm video buffering, PTZ preset, play audio clip
Frame rate Motion JPEG	30/25 (NTSC/PAL) fps 15 fps in quad view in full resolution	Pan/Tilt/Zoom	Wide range of analog PTZ cameras supported (drivers available for download at www.axis.com) Support for one PTZ driver 100 presets/camera, guard tour, PTZ control queue Supports Windows compatible joysticks
Video streaming	One individually configured H.264 and one Motion JPEG stream per channel at full frame rate. More streams if identical or limited in frame rate/resolution Controllable frame rate and bandwidth VBR/CBR H.264	General	
Image settings	Compression, color, brightness, contrast Rotation: 90°, 180°, 270° Aspect ratio correction, mirroring of images, text and image overlay, privacy mask, enhanced deinterlace filter, video termination, antialiasing, temporal noise filtering	Casing	Compatible with AXIS 291 1U Video Server Rack or the AXIS Q7900 Rack
Audio		Processor and memory	ARTPEC-4, 512 MB RAM, 128 MB Flash
Audio streaming	Two-way, full duplex and half duplex (mic/line input 1/line output). Two-way, full duplex and half duplex (mic/line input 2/line output)	Power	12 V DC, max 6 W
Audio compression	In: AAC-LC 8 or 16 kHz 8-64 kbit/s, G.711 μ-law PCM 8 kHz 64 kbit/s, G.726 ADPCM 8 kHz 32 kbit/s or 24 kbit/s Out: G.711 μ-law PCM 8 kHz 64 kbit/s, μ-law PCM 16 kHz 128 kbit/s, G.726 ADPCM 8 kHz 32 kbit/s or 24 kbit/s	Connectors	4x analog composite video BNC inputs 1x Terminal block for four configurable external inputs/outputs (on back of rack) 1x Terminal blocks for RS-485/422 (half duplex, on back of rack) 2x 3.5 mm jacks for microphone or line input (mono) 1x 3.5 mm jack for audio output (mono)
Audio input/output	External microphone input or line input Line level output Audio streaming, record (AU) and play uploaded (WAV, AU) clips AU (G.711 μ-law 8-bit 8/16 kHz mono), WAV (PCM 16-bit 8/16 kHz mono)	Operating conditions	0 °C - 45 °C (32 °F - 113 °F) Humidity 20-80% RH (non-condensing)
Network		Approvals	EN 55022, EN 61000-3-2, EN 61000-3-3, EN 55024, EN61000-6-1, EN61000-6-2, EN 60950-1, C-tick AS/NZS CISPR 22, FCC Part 15 Subpart B Class B, ICES-003 Class B, VCCI Class B, KCC Class A, UL/IEC/EN 60950-1 EN 55022 Class A for the Q7900 rack and Class B for the 291 1U rack
Security	Password protection, IP address filtering, HTTPS* encryption, IEEE 802.1X* network access control, digest authentication, user access log	Weight	210 g (0.46 lbs)
Supported protocols	IPv4/v6, HTTP, HTTPS*, IEEE 802.1X*, QoS layer 3 DiffServ, FTP, SMTP, Bonjour, UPnP, SNMPv1/v2c/v3(MIB-II), DNS, DynDNS, NTP, RTSP, RTP, TCP, UDP, IGMP, RTCP, ICMP, DHCP, ARP, SOCKS	Included accessories	Installation Guide, CD with installation and management tools, software and Users Manual, Windows decoder user licenses

* This product includes software developed by the OpenSSL Project for use in the OpenSSL Toolkit. (www.openssl.org)

More information is available at www.axis.com

Required hardware

AXIS Q7900 Rack



AXIS 291 1U Video Server Rack



Optional accessories

AXIS T8310 Video Surveillance Control Board

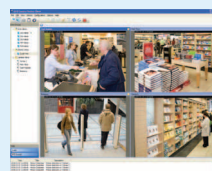

For information on AXIS Camera Station and video management software from Axis' Application Development Partners, see www.axis.com/products/video/software/

Dimensions: AXIS P7214 Video Encoder

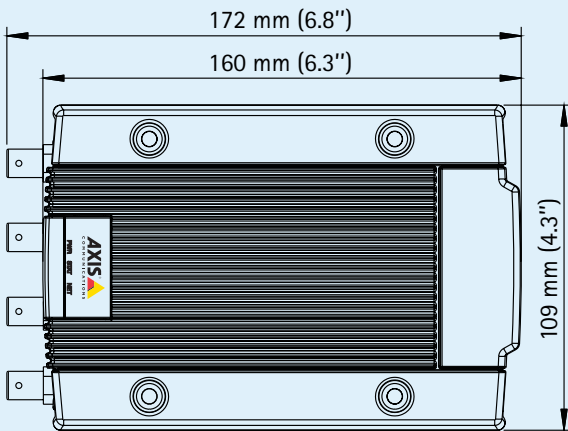

Back view

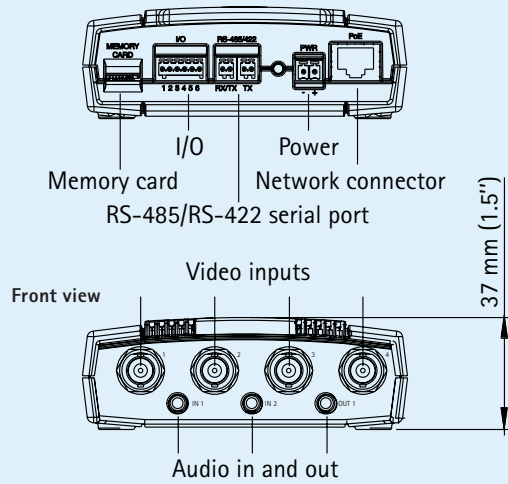

Dimensions: AXIS P7210 Video Encoder

Front view

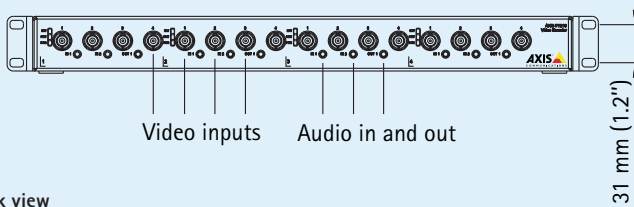

Back view

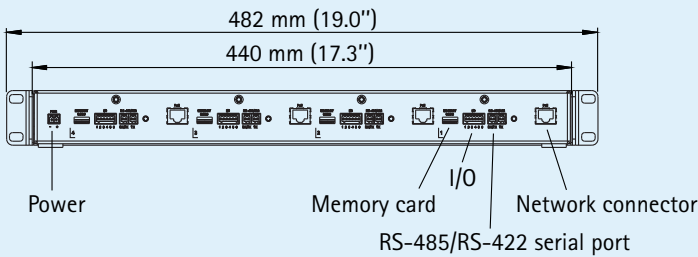

Profile view

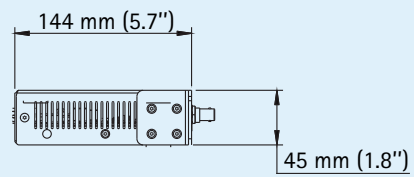

Dimensions: AXIS P7224 Video Encoder Blade

